



Collections **2018**

Design Contract **Lighting**



# Catalogue 2018







## 4 A propos

- 4-5 Notre philosophie/Our philosophy
- 6-7 Show-room/Show-room
- 8-9 Designers/Designers

## 10 Collections

### 10 Mozaik

- 12-13 Suspension nomade/Nomadic pendant lamp
- 14-15 Panneaux/Panels
- 16-17 Lustres/Chandeliers

### 18 Fleur de Kaolin

- 20-21 Appliques/Wall sconces
- 22-23 Suspension solo/Pendant lamp solo
- 22-23 Suspension trio/Pendant lamp trio
- 24-25 Lustres 18, 12, 6/Chandeliers 18, 12, 6

### 26 Pistyle

- 28-29 Lampe de bureau/Desk lamp
- 30-31 Applique/Wall sconce

### 32 Eau de Lumière

- 34-35 Lampes à poser/Table lamps
- 34-35 Lampadaire/Floor lamp
- 36-37 Appliques Petit/Wall sconces Small
- 38-39 Suspensions 2 Petit/Suspension 2 Small
- 40-41 Suspensions 5 Petit/Suspension 5 Small
- 42-43 Lustres 4 Petit/Chandeliers 4 Small
- 44-45 Lustre 4 Moyen/Chandelier 4 Medium
- 46-47 Lustre 4 Grand /Chandelier 4 Large

### 48 Couture

- 50-51 Lampes à poser/Table lamps
- 50-51 Lampadaire/Floor lamp
- 52-53 Lampadaire XXL/Floor lamp XXL
- 54-55 Appliques simples/Wall sconces
- 54-55 Appliques LED/LED Wall sconces
- 56-57 Suspensions/Pendant lamps
- 58-59 Suspension XXL/Pendant lamp XXL

### 60 Nénuphar

- 62-63 Appliques simples/Wall sconce
- 62-63 Appliques Trio/Wall sconce 3
- 64-65 Suspensions simples/Pendant lamps
- 64-65 Suspensions Trio/Pendant lamps 3
- 66-67 Plafonniers simples/Ceiling lamps
- 66-67 Plafonniers Trio/Ceiling lamps 3

### 68 Cargo

- 70-71 Lampes à poser/Table lamps
- 72-73 Lampadaires/Floor lamps
- 74-75 Appliques/Wall sconces
- 76-77 Suspensions/Pendant lamps
- 78-79 Lustres 3/Chandeliers 3

## 80 LuXiole

- 82-83 Lampe à poser/Table lamp
- 82-83 Lampadaire/Floor lamp
- 84-85 Lampadaire mural XXL/Wall lamp XXL with plug
- 84-85 Lampadaire XXL/Floor lamp XXL
- 86-87 Lampadaire mural/Wall lamp with plug
- 86-87 Applique Grand/Wall lamp large with plug
- 88-89 Applique Petit/Wall sconce
- 90-91 Suspensions/Pendant lamps
- 92-93 Lustres 5/Chandeliers 5
- 94-95 Lustres 6/Chandeliers 6

## 96 Nuage

- 98-99 Lampes à poser/Table lamps
- 100-101 Lampadaires/Floor lamps
- 102-103 Appliques simples/Wall sconces
- 104-105 Appliques LED/Wall sconces LED
- 106-107 Suspensions nomades/Nomadic pendant lamps
- 108-109 Lampe pupitre Empirique/Table lamp
- 110-111 Suspensions simples/Pendant lamps
- 112-113 Suspensions déportées/Decentered pendant lamps
- 114-115 Suspensions XXL/Pendant lamps XXL
- 118-119 Lustres 6/Chandeliers 6
- 120-121 Lustres 10/Chandeliers 10
- 122-123 Lustres 15/Chandeliers 15
- 124-127 Recommandations d'installation lustres /Installation recommendations chandeliers

## 128 Lightbook

- 128-129 Lampe de bibliothèque/Bookshelf lamp
- 130-131 Suspension/Pendant lamp
- 132-133 Applique/Wall sconce with plug

## 134 Rééditions

- 134-135 Nonne Lampe à poser/Table lamp
- 134-135 Prima Applique/Wall sconce
- 136-137 E60 Suspension/Pendant lamp
- 138-139 Radiolaire Suspension/Pendant lamp
- 138-139 Radiolaire Lampe à poser/Table lamp

## 140 Miss scope

- 140-141 Lampe à poser/Table lamp

## 142 Finitions

- 143-149 Coloris standards/Standard colors
- 150-151 Sur mesure/Custom made

## 152 Projets

- 153-161 Projets/Références/Projects/References
- 162-165 Panorama des collections/Collections overall view
- 166-167 Symboles techniques & consommation énergétique/ Technical lexicon & energy label



# DES LUMINAIRES HAUTE COUTURE FABRIQUES EN FRANCE.

# HAUTE COUTURE LIGHTING MANUFACTURED IN FRANCE.

## UN DESIGN HORS DU COMMUN

La marque incarne au sein du monde de la lumière, une certaine idée de l'élégance française et du luxe. Son design graphique et ses choix de couleurs vivants se démarquent du design conceptuel minimaliste.

Nous croyons chez Designheure que le design de la lumière doit apporter beauté, poésie et élégance tout en répondant aux nouvelles exigences d'espaces exceptionnels, qui doivent être agréables à vivre.

L'adaptabilité des espaces et la nécessité de leur polyvalence devient fondamentale. Designheure s'est engagée depuis longtemps dans la création de produits flexibles, personnalisables et réglables dans l'espace, offrant un service supplémentaire.

## ART DE VIVRE & INNOVATION

Nous créons des solutions innovantes d'éclairage pour les architectes, décorateurs et concepteurs d'éclairage qui souhaitent partager avec nous les possibilités créatives infinies que nos solutions personnalisables fournissent.

Nous pensons que chaque espace mérite un résultat final unique et mémorable. Au lieu de simplement vendre des produits prêts à l'emploi, nous vous offrons la possibilité de créer des solutions d'éclairage uniques à partir de nos concepts et de vos idées.

## UNE CREATIVITE PARTAGEE

Nous sommes impliqués avec passion dans tous nos projets pour atteindre un résultat final qui réponde parfaitement à votre vision de l'Art de vivre et au besoin des clients. Nous partageons et promovons votre créativité parce que vous faites partie de notre communauté. Nous sommes fiers de tous nos projets et collaborations.

Décrivez nous vos inspirations, nous leur donnerons vie !

## AN OUTSTANDING DESIGN

Within the lighting world, Designheure embodies the idea of French elegance and luxury. Bold graphic designs and vibrant colors diverge from minimalist, abstract designs.

We at Designheure believe that lighting design has to deliver beauty, poetry and elegance in line with today's most exceptional spaces that must be pleasant to live.

The adaptability of today's spaces and the necessity of their versatility is a fundamental consideration in our design process. It is also part of our long-standing commitment to the creation of products that offer multiple functions, remaining flexible, customizable and adjustable.

## LIFESTYLE & INNOVATION

We create innovative lighting solutions for architects, interior designers and lighting designers who share our passion for the endless creative possibilities that our customizable solutions provide.

We believe that each space deserves to be unique and memorable. Instead of simply selling ready-made products, we offer designers the possibility to create unique lighting solutions from our concepts and their ideas.

## A SHARED CREATIVITY

We are passionately involved in all of our projects, ensuring that the final result suits perfectly the designer's vision and client's needs.

We are proud of all our projects and collaborations, and we share and promote this creativity as a member of the global design community.

Share your inspirations with us, and we shall give them life!



Jean-Baptiste Collod, Président/President & Bénédicte Collod, Directrice générale/Managing director







# Show-Room



# Designers

## Davide Oppizzi



Designer lumière,

En 2001, Davide Oppizzi fonde l'agence DCUBE design espaces lumière SA à Genève, spécialisée en création et développement de projets haut de gamme dans les domaines de l'éclairage, du design, des greentech et de l'architecture. Lumière et matière: en quête incessante de lignes pures et authentiques, celles-là mêmes qui élèvent l'objet au rang d'un raffinement esthétique atemporel, confidentiel et fonctionnel, Davide Oppizzi se spécialise dans l'art de la lumière, seule capable, selon lui, de sublimer la matière qu'il travaille.

L'imagination de Davide Oppizzi, sa vision émotionnelle du monde matériel et immatériel, ainsi que son expertise dans des domaines niche le portent sur le devant de la scène internationale. Des marques prestigieuses mondiales comme Chanel, Louis Vuitton ou Graff le mandatent pour créer des projets reflétant le lien profond entre l'être et la nature qui l'entoure, cette nature qui nourrit à tout instant ses inspirations.

Lighting Designer,

In 2001, Davide Oppizzi established DCUBE Design Light Spaces S.A. in Geneva, specializing in the creation of high-end, multi-disciplinary projects across lighting, design, green technologies and architecture.

David is in a constant search for pure and authentic lines that raise both the functional and timeless aesthetic of his designs. He has dedicated his own work to the art of light, which, he states, sublimes the materials he works on.

David's international renown is, in large part, due to his emotional vision of the material and immaterial world, as well as his technical expertise. He has been selected by prestigious, worldwide brands including Chanel, Louis Vuitton and Graff to create project that reflect the deep link between man and David's inspiration, nature.

## Emmanuelle Legavre



Designer et Décoratrice d'intérieur,

Après des études à l'École des Beaux Arts de Nantes, Emmanuelle choisit de se consacrer au design.

Contemporain chic, matières luxueuses, élégance des lignes, décalages surprenants.... Telles sont les composantes du style d'Emmanuelle Legavre. Tour à tour designer, architecte d'intérieur ou sculpteur, Emmanuelle Legavre dessine des univers et des objets qui traduisent son énergie et sa passion de l'exceptionnel. Elle fonde EL Paris afin de pouvoir réaliser des projets qui lui ressemblent et répondent à son exigence du détail et à son goût de l'audace.

Product Designer and Interior Designer,

Trained in design at the École des Beaux-Arts, Emmanuelle Legavre's style is known for her contemporary chic, luxurious materials, elegant lines and astonishing contradictions.

Her designs, sculptures and interior spaces reflect an energy and passion for exceptional objects.

She founded her firm, EL Paris, so that she can continue to take on projects that complement her commitment to detail, and match her sense of daring.

## Kristian Gavaille



Architecte et Designer,

Diplômé de l'École d'Architecture de Toulouse. La rencontre, fulgurante, avec le pape du Design Philippe Starck avec lequel il collabore durant 5 ans, lui permettra de faire la diagonale entre Architecture et Design.

Il conçoit des objets pimpants, colorés, bavards, inattendus et décalés. Tout ce qu'il fait est changeant comme dans la mode, qu'il aime parce qu'éphémère. Sa culture c'est la rue. C'est là qu'il pioche son métissage, son nomadisme.

Sélectionné par une carte blanche au Via en 1991, il a été élu créateur de l'année en 1992 et présentera plusieurs collections chez le grand éditeur Pierre Studenmeyer fondateur de la galerie NEOTU. Kristian Gavaille aime raconter des histoires...

Architect and Designer,

A graduate of the Toulouse School of Architecture, Kristian Gavaille's tutelage under one of the masters in contemporary design, Phillippe Starck, is reflected in his melding of both product design and architecture.

Kristian designs colorful, talkative, unexpected and offbeat objects. Like fashion, his work is constantly evolving and transitory. His inspiration is the melting pot of the streets.

He was elected Via's Designer of the Year 1992, and has had several of his collections shown at the renowned publisher Peter Studenmeyer's Neotu gallery.



## Hervé Langlais



Architecte et Designer,

Après des études à l'École d'Architecture de Normandie à Rouen, il a été le collaborateur de l'architecte Paul Andreu pendant plus de quinze ans. Il a travaillé notamment sur le Grand Théâtre National de Chine à Pékin, l'Oriental Art Center de Shanghai et de nombreux autres projets en France comme à l'étranger. Il a également signé des aménagements intérieurs pour des clients privés et participé à de nombreux projets avec le designer Kristian Gavaille.

Depuis 2012, il codirige la galerie NEGROPONTES pour laquelle il dessine chaque année une collection d'objets et de mobiliers, pièces uniques dans la pure tradition des Arts Décoratifs à la française.

Ses autres créations sont éditées par Drugeot Labo, La Fibule, LELABO design, D'Argentat et CVL.

Architect and Designer,

Trained at the School of Architecture of Normandie in Rouen, Hervé Langlais spent over fifteen years working with architect Paul Andreu on projects including The National Grand Theatre of China in Beijing and The Oriental Art Center in Shanghai.

Since then, Hervé has worked on interior designs for private clients and participated in numerous projects with designer Kristian Gavaille.

Since 2012, he also serves as co-director of the Negropontes Gallery where he annually exhibits a collection of objects and furniture—unique pieces in the purest tradition of French Decorative Arts.

His works have been published by Drugeot Lab, The fibula, LELABO design, D'Argentat and CVL.

## Laurent Bailly



Designer,

Laurent Bailly a travaillé plusieurs années avec des architectes et des designers, dont Joël Laffly (montres Herbelin®, Swatch®,...).

Il a fondé en 2007 la Société Applymage dont il dessine et conçoit les produits destinés à de grands groupes.

L'idée de créer des objets aux lignes épurées, sans artifices sinon techniques, mais dotés de plusieurs fonctions est toujours pour lui un pari excitant.

Plusieurs de ses créations ont reçu le label de l'« Observateur du Design » : le lampadaire Light & News en 2011, le distributeur de capsules Evolusso en 2012 et la Collection de Mobilier d'Art Maderno en 2013.

Designer,

Laurent Bailly has worked alongside numerous architects and designers, including Joël Laffly (Michel Herbelin® watches, Swatch®).

In 2007, he founded the APPLYMAGE Company for whom he designs and develops products intended for the broader market.

The idea of designing objects with pure and natural lines, without any pretence or artifice other than technical, and yet endowed with multiple functions, has always been a welcome challenge for Laurent.

Many of his designs have received the Label de l'Observateur du Design award including: The Lampfloor Magazine Rack, Light & News, The Capsule Dispenser Evolusso, and The Maderno Collection of Art Furniture.

## Raoul Raba

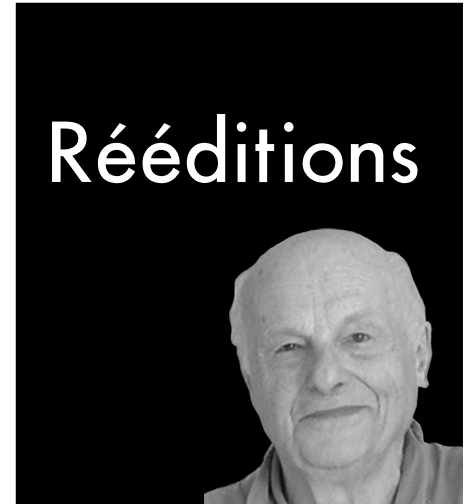

Design automobile, Architecture, Luminaires

Issu des Beaux Arts et autodidacte du design, Raoul Raba est avant tout peintre et sculpteur. Consacré par le «Grand Prix de Rome » en 1955, son talent se révèle multiple.

Design automobile et collaboration avec Flaminio Bertoni au bureau d'études Citroën où il s'illustre en dessinant les célèbres phares racés de la Citroën DS.

Architecture aux côtés d'Olivier-Clément Cacoub, avec qui il réalise l'imposant «Signal de Skanes» et différentes ornementsations pour le palais du président H.Bourguiba.

Automotive Design, Architecture, Lighting Design.

A product of the École des Beaux-Arts, self-taught designer, Raoul Raba, is foremost a painter and sculptor. His multiple talents garnered the Grand Prix de Rome in 1955, which heralded a long, successful career.

His automotive design, in cooperation with Flaminio Bertoni in Citroën's research department, further distinguished his talents via his creation of the famous racy headlights of Citroën DS. And, alongside Olivier Clément Cacoub, Raoul showcased his architectural skill with his production of the impressive Signal Skanes and various decorations for the palace of President Habib Bourguiba.

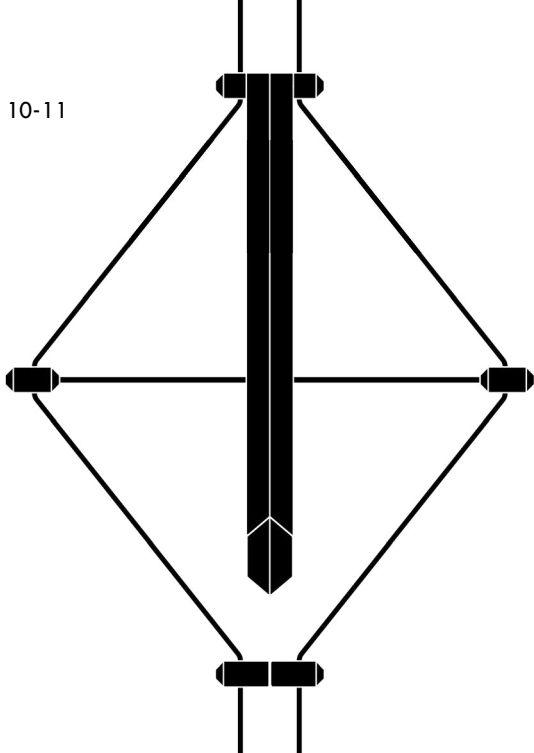

# Mozaik

Daide Oppizzi



**Mozaik** est une collection à la fois architecturale et modulable qui s'inscrit dans l'espace : à la fois lumineuse et panneau séparateur selon la version choisie.

Créé par le designer Davide Oppizzi, le design a été axé sur des formes géométriques qui s'inspirent du concept des mosaïques. Il s'agissait aussi de créer une surface lumineuse, tombant comme une pluie de météorites et non plus seulement d'apporter juste un point lumineux. Conforme à l'ADN de Designheure, cette collection reprend les possibilités infinies de finitions qu'offrent le tissu et le fil textile, pour être agencées en un jeu de lumière graphique & personnalisable, qui sculpte l'espace.

Au sein de la famille de produits, la collection est déclinée en plusieurs tailles et modèles : suspensions, panneaux, lustres. "

" **Mozaik** is an architectural and modulable collection designed to structure the space: at the same time lamp and space separator according to the chosen version.

Designed by Davide Oppizzi, his inspiration comes from the concept of mosaics and its geometric shapes. It was also about creating a luminous surface, falling like a rain of meteorites, cutting the space and not just bringing a luminous point.

In compliance with the DNA of Designheure, this collection resumes the infinite possibilities of finishes that offer fabrics and textile cord to order it in a graphic and customizable lighting panel, sculpturing the space.

Within the product line, the collection is declined in several sizes and models: suspension, panels, chandeliers. "

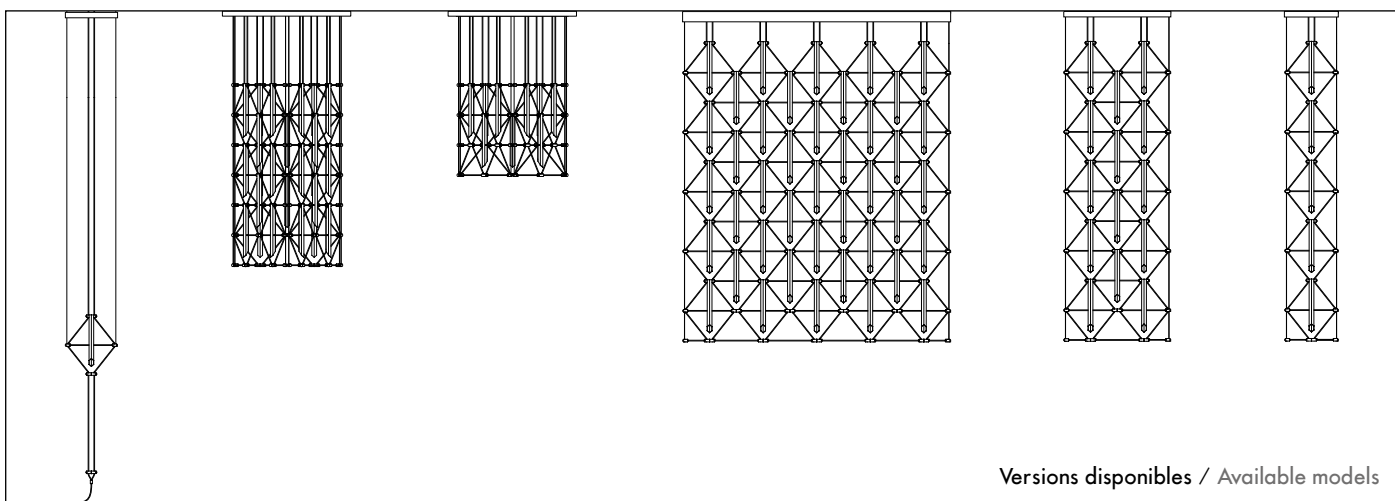

Versions disponibles / Available models



# Collection Mozaik

Design : Davide Oppizzi

# Mozaik

Davide Oppizzi



## Suspension Nomade ■ Mozaik

### //

Suspendu dans les airs par une simple fixation au plafond, ce luminaire est conçu pour s'adapter à tous les espaces. La suspension se branche sur une simple prise et joue le rôle d'un lampadaire ou d'une lampe de chevet en s'affranchissant de l'alimentation électrique au plafond. A assembler en grappe de deux ou trois, à différentes hauteurs, telle une sculpture. "

"Suspended in the air with a single ceiling mount, this light is designed to fit all environments from residential to commercial. The pending light connects to a simple plug and can play the role of a floor lamp or a bedside lamp saving the need to require power from the ceiling. Two or three can be assembled together as a cluster, at different heights, like a sculpture. "

#### ■ Suspension Nomade Mozaik

Ref : Ssmoz

L. 45 x l. 5 x H. 300 cm - Abj/Ls : L. 4 x l. 5 x H. 45 cm - Fil textile/Textile cord  
2 m/6.6' - Câble acier/Steel cable 2 x 2 m/2 x 6.6' - 1 x Max 3 W -  
230 V - Ampoule/Bulb GU4 12V - Fournie/Incl. - Interrupteur à pied/  
foot switch.



#### Finitions/ Finishes

Voir page 143-149/See page 143-149

#### Matériaux Materials

Tissus, laiton brossé, acier laqué, fibre de verre, fil tissé coloré  
Fabric, brushed brass, lacquered steel, fiber glass, colored textile  
cord.

MADE IN  
FRANCE

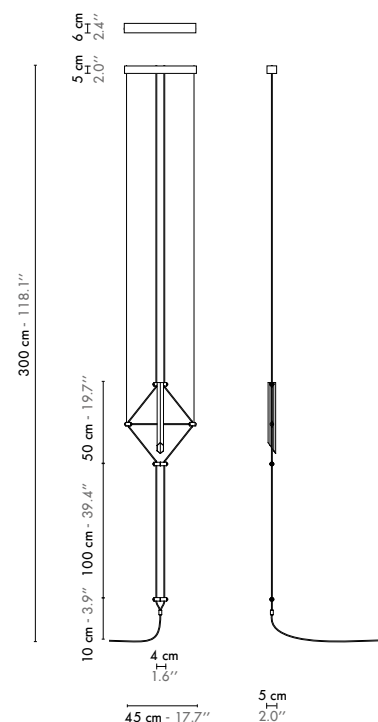





# Mozaik

Davide Oppizzi

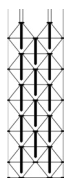

## Panneau 5x5 ■ Mozaik

## Panneau 2x5 ■ Mozaik

## Panneau 1x5 ■ Mozaik



Séparateurs d'espace, ces panneaux de lumière procurent une surface décorative et graphique qui tout en recréant une intimité, offrent en transparence une vision de l'architecture. Disponible en trois tailles. "

" Space dividers, these light panels provide a decorative and graphic surface which while recreating an intimacy, offer in transparency a vision of the architecture. Available in three sizes. "

<p><b>1</b> Panneau 5x5 Mozaik</p> <p>Ref : Pa5x5moz41a</p>	<p><b>Hauteur sous plafond min 2,9 m/Ceiling height min 9.5'</b></p> <p>L. 225 x l. 16 x H. 280 cm - Abj/Ls : L. 4 x l. 5 x H. 45 cm - Fil textile au dessus du panneau/Textile cord above panel 10 x 25 cm/10 x 9.8"</p> <p>Câble acier/Steel cable 2 x 3 m/2 x 9.8' - 41 x Max 3 W 230 V</p> <p>Ampoule/Bulb GU4 12V - Fournie/Incl.</p> <p></p>
<p><b>2</b> Panneau 2x5 Mozaik</p> <p>Ref : Pa2x5moz14a</p>	<p><b>Hauteur sous plafond min 2,9 m/Ceiling height min 9.5'</b></p> <p>L. 90 x l. 6 x H. 280 cm - Abj/Ls : L. 4 x l. 5 x H. 45 cm - Fil textile au dessus du panneau/Textile cord above panel 4 x 25 cm/4 x 9.8"</p> <p>Câble acier/Steel cable 2 x 3 m/2 x 9.8' - 14 x Max 3 W - 230 V - Ampoule/Bulb GU4 12V - Fournie/Incl.</p> <p></p>
<p><b>3</b> Panneau 1x5 Mozaik</p> <p>Ref : Pa1x5moz5a</p>	<p><b>Hauteur sous plafond min 2,9 m/Ceiling height min 9.5'</b></p> <p>L. 45 x l. 6 x H. 280 cm - Abj/Ls : L. 4 x l. 5 x H. 45 cm - Fil textile au dessus du panneau/Textile cord above panel 2 x 25 cm/2 x 9.8"</p> <p>Câble acier/Steel cable 2 x 3 m/2 x 9.8' - 5 x Max 3 W - 230 V - Ampoule/Bulb GU4 12V - Fournie/Incl.</p> <p></p>
<p>Finitions/ Finishes Voir page 143-149/See page 143-149</p>	
<p>Matériaux Materials Tissus, laiton brossé, acier laqué, fibre de verre, fil tissé coloré Fabric, brushed brass, lacquered steel, fiber glass, colored textile cord.</p>	

**MADE IN FRANCE**

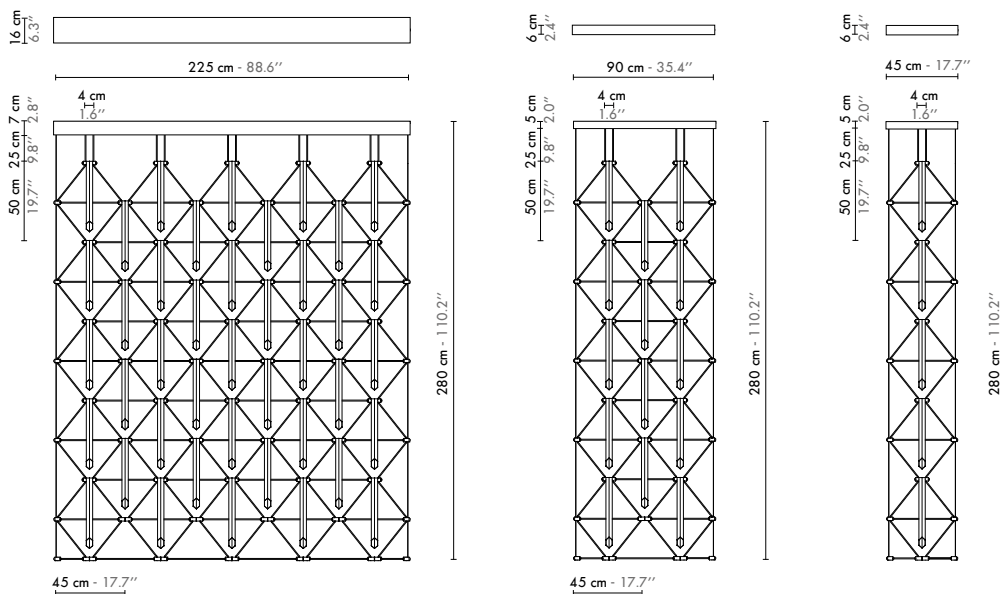

**1** Ref : Pa5x5moz41a

**2** Ref : Pa2x5moz14a

**3** Ref : Pa1x5moz5a





# Mozaik

Davide Oppizzi

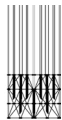

## Lustre Trio ■ Mozaik

## Lustre Trio Flat ■ Mozaik



Composés de 3 panneaux de lumière disposés en triangle, à l'image d'un prisme, ces lustres d'une remarquable modernité procurent une agréable lumière, rétro-éclairant la couleur intérieure. Disponible en deux tailles. "

" Compound of 3 light panels, arranged in triangle, just like a prism, these outstanding contemporary chandeliers provide a pleasant light, backlighting the internal color. Available in two sizes. "

<p><b>1</b> Lustre Trio Mozaik</p> <p>Ref : Lut3x2moz24a</p>	<p>Hauteur sous plafond min 3,65 m / Ceiling height min 12'</p> <p>L. 90 x l. 78 x H. 205 cm - Abj./Ls : L. 4 x l. 5 x H. 45 cm - Fil textile/Textile cord 12 x 50 cm / 12 x 1.6' - Câble acier/Steel cable 6 x 2 m / 6 x 6.6' 24 x Max 3 W - 230 V - Ampoule/Bulb GU4 12V - Fournie/Incl.</p> <p> </p>
<p><b>2</b> Lustre Trio Flat Mozaik</p> <p>Ref : Lut1,5x2moz9a</p>	<p>Hauteur sous plafond min 2,90 m / Ceiling height min 9.5'</p> <p>L. 90 x l. 78 x H. 130 cm - Abj./Ls : L. 4 x l. 5 x H. 45 cm - Fil textile/Textile cord 12 x 50 cm / 12 x 1.6' - Câble acier/Steel cable 6 x 1.25 m / 6 x 4.1' - 9 x Max 3 W - 230 V - Ampoule/Bulb GU4 12V - Fournie/Incl.</p> <p> </p>
<p>Finitions/ Finishes : Voir page 143-149/See page 143-149</p>	
<p>Matériaux/ Materials : Tissus, laiton brossé, acier laqué, fibre de verre, fil tissé coloré / Fabric, brushed brass, lacquered steel, fiber glass, colored textile cord.</p>	

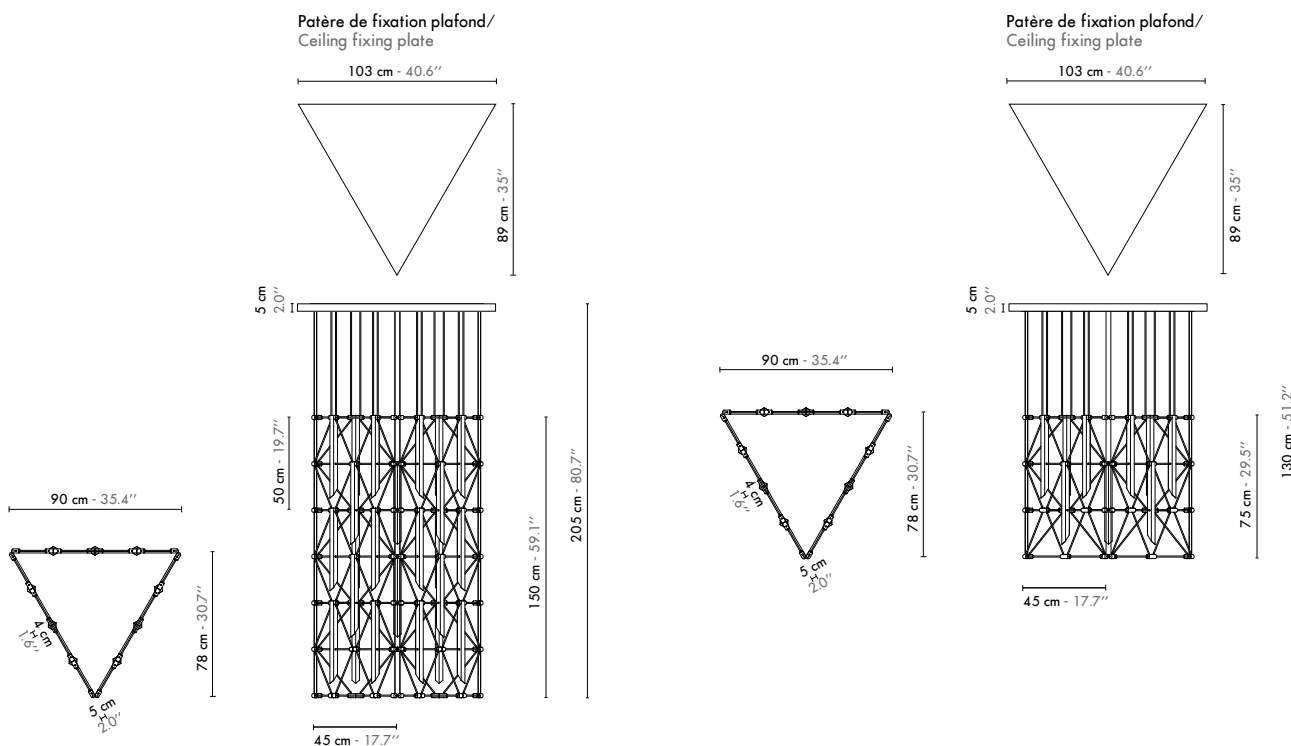

**1** Ref : Lut3x2moz24a

**2** Ref : Lut1,5x2moz9a



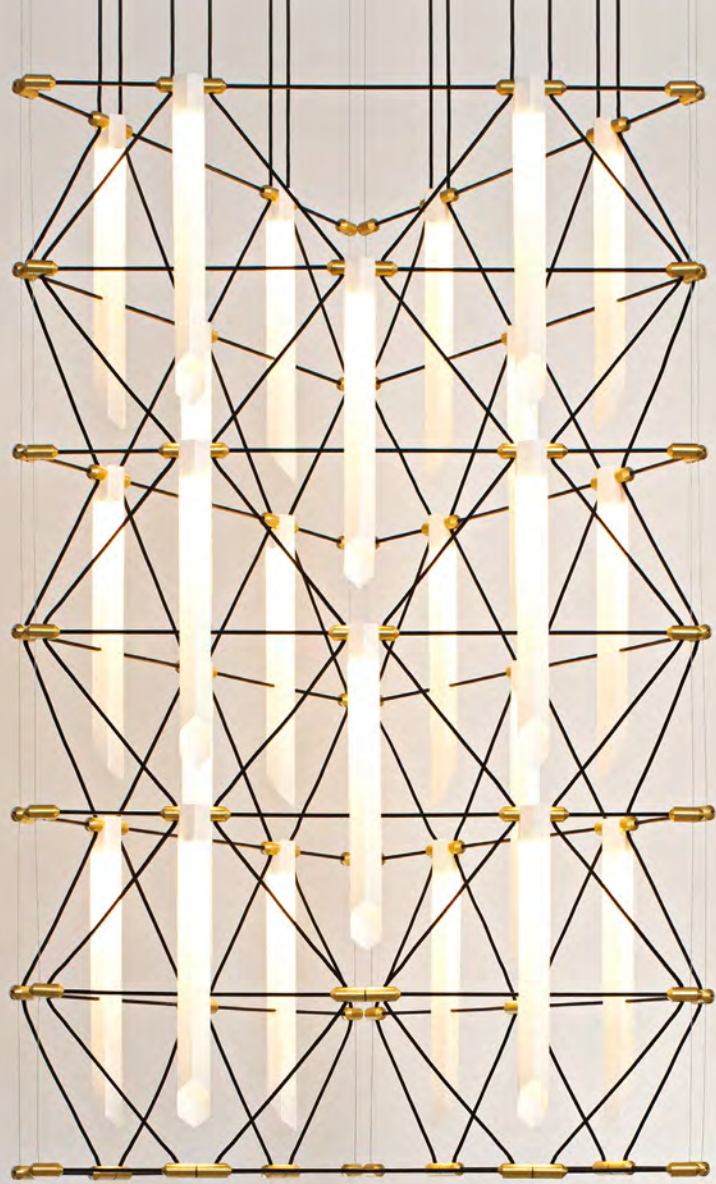

1



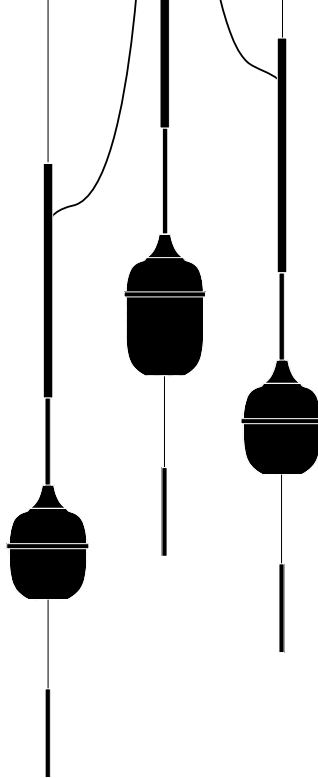

# Fleur de Kaolin

Designheure studio & HAVILAND  
LIMOGES FRANCE 1842



## Un hommage au monde de la porcelaine

Séduite par le savoir faire unique de la Maison Haviland, un des derniers porcelainiers de France à réaliser sa porcelaine dans son intégralité à Limoges, de la fabrication à la décoration de ses services, Designheure est fière d'intégrer à son nouveau design les éléments de la collection Infini pour en faire un luminaire bijoux, 100% français.

L'esprit de la collection, axé sur la verticalité du graphisme des éléments en porcelaine, est inspiré par l'idée du carillon, ou du bâton de pluie. Tout en poésie et en raffinement, des éléments de laiton brossé prolongent les suspensions comme un mobile. Au sein de la famille de produits, la collection est déclinée en lustres, suspensions et appliques. "

## " A tribute to the world of porcelain

Seduced by the unique know-how of Maison Haviland, one of the last porcelain manufacturers in France to produce its porcelain in Limoges in its entirety, from the manufacture to the decoration of its services, Designheure is proud to integrate in its new design the elements of the Infini collection to sublimate them again in a jewelry fixture, 100% French.

The spirit of the collection, centered on the verticality of the graphic design of the porcelain elements, is inspired by the idea of the carillon or the rain stick. All in poetry and refinement, brushed brass elements extend the suspensions like a mobile. Within the product family, the collection is available in chandeliers, pendant lights and wall lamps. "

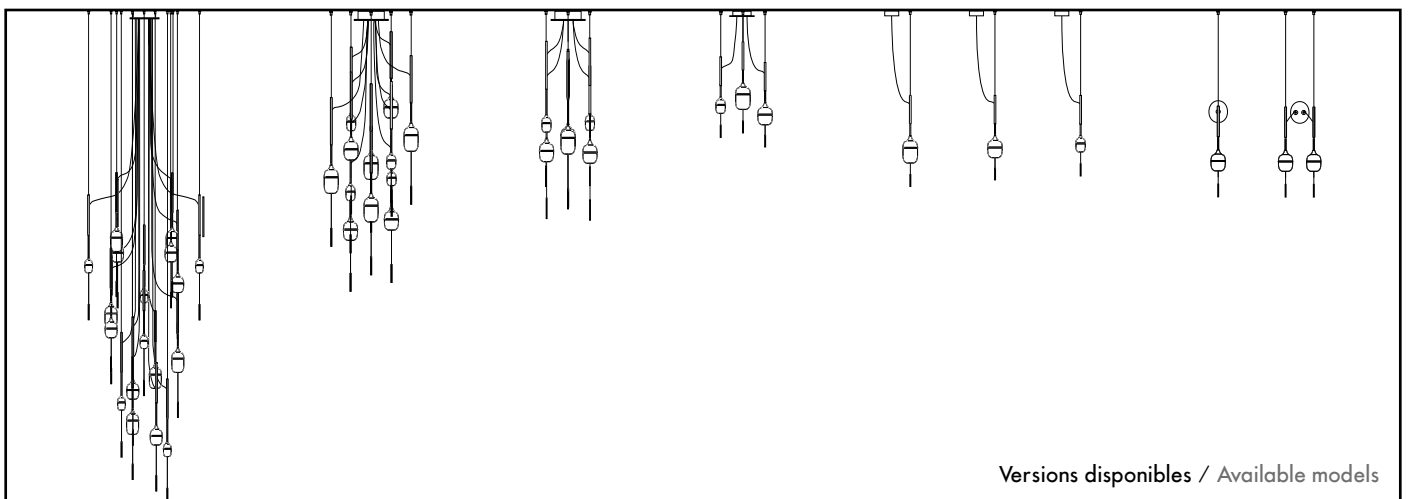

Versions disponibles / Available models





# Collection Fleur de Kaolin

Designheure studio & Haviland

## Applique suspendue solo 1 Fleur de Kaolin

## Applique suspendue duo 2 Fleur de Kaolin

# Fleur de Kaolin

Designheure studio & **HAVILAND**  
LIMOGES FRANCE 1842



Appliques suspendues, en porcelaine Haviland (motif Infini), déclinées en version solo ou duo. ”

“ Hanging porcelain wall lamps Haviland (Infini pattern), available in solo or duo versions. ”

### 1 Applique solo Fleur de Kaolin

- Grand/Ref : A1gfk
- Moyen/Ref : A1mfk
- Petit/Ref : A1pfk

L. 9,6 x l. 14 x H. 55,5 cm - Abj Grand/Ls Large : Ø8,6 x H. 12,5 cm  
L. 9,6 x l. 14 x H. 52,5 cm - Abj Moyen/Ls Medium : Ø8,6 x H. 9,6 cm  
L. 9,6 x l. 12 x H. 50,2 cm - Abj Petit/Ls Small : Ø5,5 x H. 8,2 cm  
Câble acier/Steel cable 2 m/6.6'  
1 x Max 3 W - 230 V - Ampoule LED/Bulb LED G9 - Fournie/Incl.



### 2 Applique duo Fleur de Kaolin

- Grand/Ref : A2gfk
- Moyen/Ref : A2mfk
- Petit/Ref : A2pfk

L. 22,6 x l. 14 x H. 55,5 cm - Abj Grand/Ls Large : Ø8,6 x H. 12,5 cm  
L. 22,6 x l. 14 x H. 52,5 cm - Abj Moyen/Ls Medium : Ø8,6 x H. 9,6 cm  
L. 16 x l. 12 x H. 50,2 cm - Abj Petit/Ls Small : Ø5,5 x H. 8,2 cm  
Câble acier/Steel cable 2 m/6.6'  
2 x Max 3 W - 230 V - Ampoule LED/Bulb LED G9 - Fournie/Incl.



Finitions/Finishes

Voir page 143-149/See page 143-149

Matériaux  
Materials

Porcelaine, laiton brossé, acier laqué, fil tissé coloré  
Porcelain, brushed brass, lacquered steel, colored textile cord.

MADE IN  
FRANCE

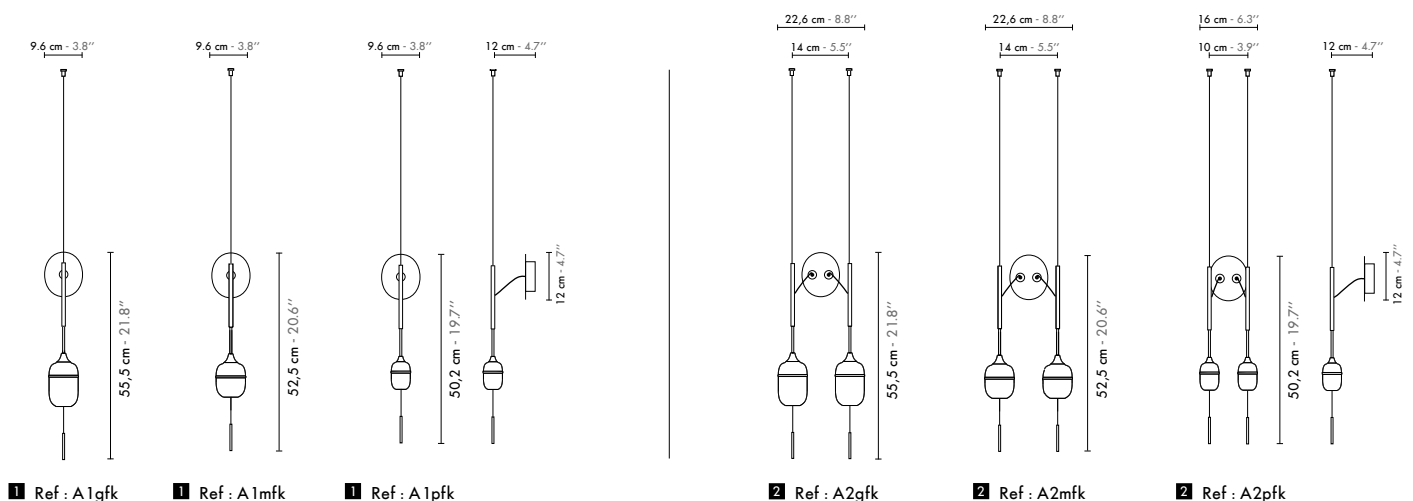







## Suspension solo 1 Fleur de Kaolin

## Suspension trio 2 Fleur de Kaolin

# Fleur de Kaolin

Designheure studio & **HAVILAND**  
LIMOGES FRANCE 1842

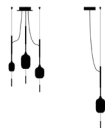

Assemblées en grappe à différentes hauteurs, ou en solitaire, ces suspensions sublimeront votre espace par leur raffinement et leur poésie. "

" Assembled together at different heights like a cluster, or solo, these suspensions will enhance your space with their refinement and poetry. "

### 1 Suspension solo Fleur de Kaolin

Hauteur sous plafond min 2,7 m/Ceiling height min 8.9'

- Grand/Ref : Sgfk L. 20 x H. 104 cm - Abj Grand/Ls Large : Ø8,6 x H. 12,5 cm
- Moyen/Ref : Smfk L. 20 x H. 102 cm - Abj Moyen/Ls Medium : Ø8,6 x H. 9,6 cm
- Petit/Ref : Spfk L. 18,5 x H. 100 cm - Abj Petit/Ls Small : Ø5,5 x H. 8,2 cm

1 x Max 3 W - 230 V - Ampoule LED/Bulb LED G9 - Fournie/Incl.



### 2 Suspension trio Fleur de Kaolin

Hauteur sous plafond min 2,7 m/Ceiling height min 8.9'

- Ref: S3fk1g1m1p80 Ø 28 x H. 80 cm
- Ref: S3fk1g1m1p120 Ø 28 x H. 120 cm

1 grand, 1 moyen,  
1 petit

Abj Grand/Ls Large : Ø8,6 x H. 12,5 cm - Abj Moyen/  
Ls Medium : Ø8,6 x H. 9,6 cm - Abj Petit/Ls Small : Ø5,5 x H. 8,2 cm

3 x Max 3 W - 230 V - Ampoule LED/Bulb LED G9 - Fournie/Incl.



Finitions/Finishes Voir page 143-149/See page 143-149

Matériaux  
Materials

Porcelaine, laiton brossé, acier laqué, fil tissé coloré  
Porcelain, brushed brass, lacquered steel, colored textile cord.

**MADE IN  
FRANCE**

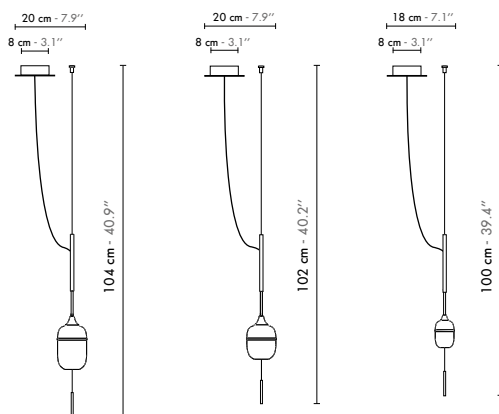

1 Ref : Sgfk

1 Ref : Smfk

1 Ref : Spfk

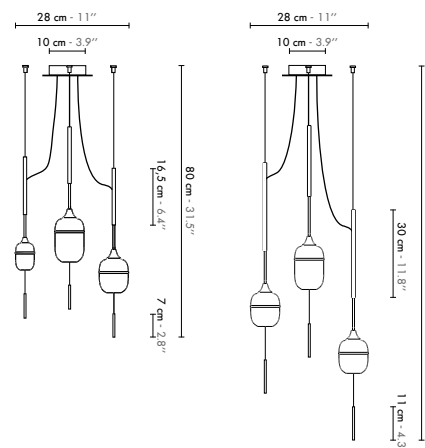

2 Ref : S3fk1g1m1p80

2 Ref : S3fk1g1m1p120



2



# Fleur de Kaolin

Designheure studio & **HAVILAND**  
LIMOGES FRANCE 1842



**Lustre 6** ■  
**Fleur de Kaolin**















**Lustre 12** ■  
**Fleur de Kaolin**

**Lustre 18** ■  
**Fleur de Kaolin**



Disponibles en trois tailles, ces suspensions bijoux rétro-éclairent la matière sensuelle du biscuit de porcelaine et son graphisme vertical. "

" Available in three sizes, these jewelry suspensions backlight the sensual material of the porcelain biscuit and its vertical graphics. "

- |  |  |   |
|--|--|---|
| <p><b>1</b> Lustre 6<br/>Fleur de Kaolin</p> <p>Ref:<br/>Lu6fk2g2m2p</p>   | <p>Hauteur sous plafond min 3,2 m / Ceiling height min 10.5'</p> <p>Ø 40 x H. 120 cm - Abj Petit/Ls Small : Ø5,5 x H. 8,2 cm - Abj Moyen/Ls Medium : Ø8,6 x H. 9,6 cm - Abj Grand/Ls Large : Ø8,6 x H. 12,5 cm</p> <p>Fil textile/Textile cord 1 m/3.3' - 6 x Max 3 W - 230 V - Ampoule LED/Bulb LED G9 - Fournie/Incl.</p>  |                |
| <p><b>2</b> Lustre 12<br/>Fleur de Kaolin</p> <p>Ref:<br/>Lu12fk4g4m4p</p> | <p>Hauteur sous plafond min 3,6 m / Ceiling height min 11.8'</p> <p>Ø 60 x H. 160 cm - Abj Petit/Ls Small : Ø5,5 x H. 8,2 cm - Abj Moyen/Ls Medium : Ø8,6 x H. 9,6 cm - Abj Grand/Ls Large : Ø8,6 x H. 12,5 cm</p> <p>Fil textile/Textile cord 2 m/6.6' - 12 x Max 3 W - 230 V - Ampoule LED/Bulb LED G9 - Fournie/Incl.</p> |      |
| <p><b>3</b> Lustre 18<br/>Fleur de Kaolin</p> <p>Ref:<br/>Lu18fk6g6m6p</p> | <p>Hauteur sous plafond min 5,2 m / Ceiling height min 17.1'</p> <p>Ø 80 x H. 320 cm - Abj Petit/Ls Small : Ø5,5 x H. 8,2 cm - Abj Moyen/Ls Medium : Ø8,6 x H. 9,6 cm - Abj Grand/Ls Large : Ø8,6 x H. 12,5 cm</p> <p>Fil textile/Textile cord 3 m/9.8' - 18 x Max 3 W - 230 V - Ampoule LED/Bulb LED G9 - Fournie/Incl.</p> |      |

Finitions/  
Finishes

Voir page 143-149/See page 143-149

Matériaux  
Materials

Porcelaine, laiton brossé, acier laqué, fil tissé coloré  
Porcelain, brushed brass, lacquered steel, colored textile cord.

**MADE IN  
FRANCE**

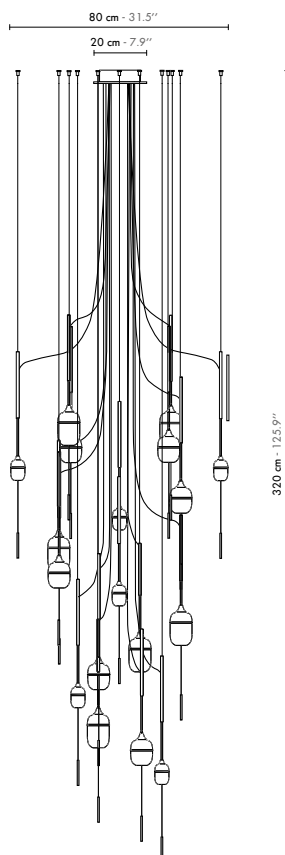

**3** Ref : Lu18fk6g6m6p

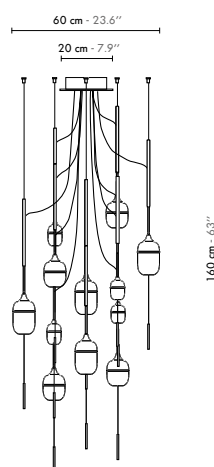

**2** Ref : Lu12fk4g4m4p

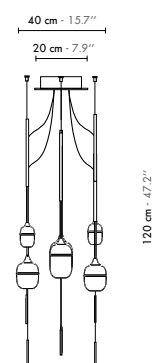

**1** Ref : Lu6fk2g2m2p







# Pistyle

Daide Oppizzi

## // La nature s'invite dans nos bureaux

Inspiré par les formes végétales des Oiseaux de paradis, Davide Oppizzi signe cette collection de luminaires **Pistyle** spécialement conçue pour les bureaux dans un esprit naturel et ludique.

Cette collection aux lignes pures se révèle très technique par ses 3 axes de rotation qui lui permettent d'offrir un éclairage optimal. L'intensité de l'éclairage s'adapte grâce à un variateur tactile disposé sur la base ; Celle-ci permet également un rangement pratique du cordon autour du yoyo.

Ses couleurs vives et ses positions expressives donnent un caractère singulier et végétal à cette lampe qui s'intègre parfaitement à l'univers du bureau. "

### " Nature is invited in our offices

Inspired by the bird of paradise flower, Davide Oppizzi designed the **Pistyle** lighting collection to bring freshness and playfulness to the office. The collection's lively colors and "yo-yo"-like base belie lighting sophisticated enough for the office.

**Pistyle** has three axes of rotation, which allows it to offer optimal lighting regarding of the work environment. The light's intensity also adapts on its own thanks to a tactile variator arranged on the base that also allows for ease of use.

The result is a light that very much moves like a plant in nature—with intense life and vibrancy. "

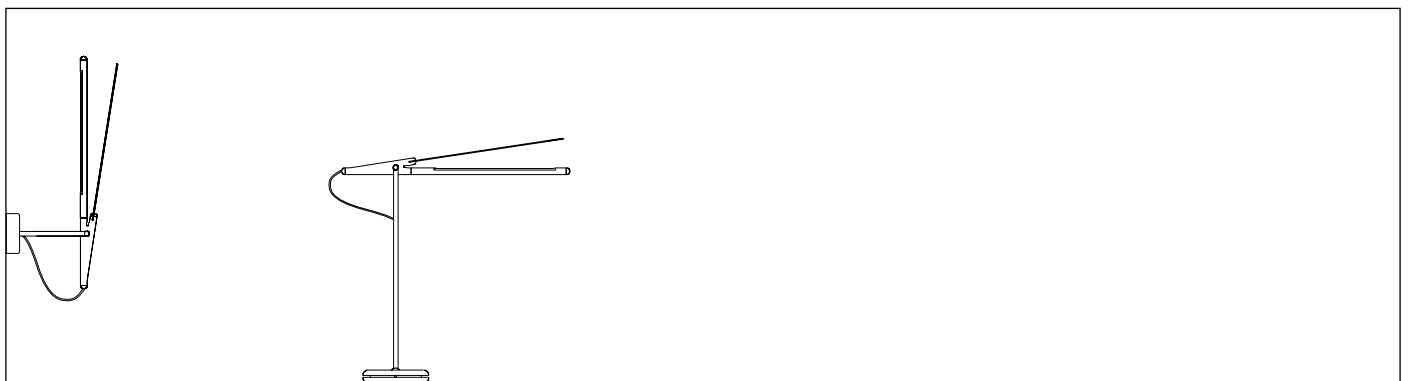





# Collection Pistyle

Design : Davide Oppizzi

# Pistyle

Davide Oppizzi



## Lampe de bureau Pistyle ■



Cette lampe versatile offre trois axes rotatifs dont une orientation de la lumière à 360 degrés. Enfin une vraie lampe technique LED avec une dimension humaine, naturelle et décorative pour nos bureaux ! “

**Position 1 :** elle éclaire la table dans une configuration perpendiculaire avec le LED orienté au choix vers la surface de la table ou en rétro-éclairage de la feuille en laine feutrée.

**Position 2 :** la lampe se dresse dans une position verticale et devient roseau décoratif à combiner avec différents coloris au centre d’un pôle de plusieurs tables.

**Position 3 :** Son pied articulé permet d’incliner la lampe en allongeant son flux lumineux tout en gardant l’horizontalité de la source.

This versatile lamp offers three rotary axes including a light that can be oriented 360 degrees. At last, there is a real LED lamp with a livable, natural and decorative dimension for offices!

**Position 1 :** Illuminates the table in a perpendicular configuration with the LED facing either to the surface or backlight on the felted wool leaf.

**Position 2 :** The lamp stands in an upright position and becomes decorative “reed”. It can be combed with different colors in the center of a cluster.

**Position 3 :** The articulated foot can tilt the lamp, lengthening its light while keeping the light source horizontal.

<p>■ Lampe de bureau Pistyle Pistyle desk lamp Ref : Lpi</p>	<p>L. 61 x l. 18 x H. 66 cm - Fil textile/Textile cord 2 m/6.6’ 8 W - 230 V/120 V - 3000 K - IRC &gt; 85 Variateur tactile/Dimmer touch button</p> <p>Integrated LED CE ENEC   850° </p>
<p>Finitions/ Finishes</p>	<p>Voir page 143-149/See page 143-149</p>
<p>Matériaux Materials</p>	<p>Aluminium laqué, laine feutrée, fil tissé coloré. Lacquered aluminum, lightweight felt, colored textile cord.</p>

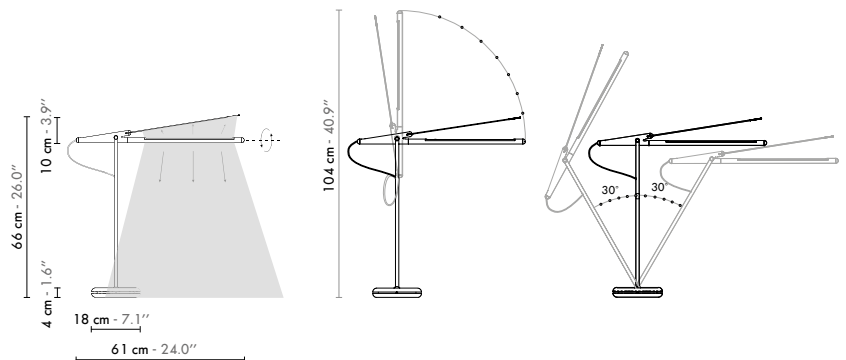





# Pistyle

Daide Oppizzi



## Applique Pistyle ■



L'applique Pistyle peut être installée dans deux positions :

- l'une en éclairage direct, la tige led orientée vers le mur, servant d'écran réflecteur ;
- l'autre en éclairage indirect vers la feuille en laine feutrée pour une lumière tamisée."

The Pistyle wall lamp can be installed in two positions:

- One for direct lighting, with the LED rod facing the wall and serving as reflective screen;
- Another as an indirect light, which faces the lightweight felt for a softer effect.

■ Applique Pistyle Wall lamp Pistyle	Position 1 : L. 22 x l. 8 x H. 61 cm
	Position 2 : L. 28 x l. 8 x H. 61 cm Fil textile/Textile cord 0,3 m/1'

8 W - 230 V/120 V - 3000 K - IRC > 85

Ref : Api

Integrated LED **CE ENEC**   850' 

Finitions/  
Finishes

Voir page 143-149/See page 143-149

Matériaux  
Materials

Aluminium, laine feutrée, fil tissé coloré.  
Aluminum, lightweight felt, colored textile cord.

**MADE IN  
FRANCE**

### 2 positions

- 1 Éclairage direct  
Direct lighting
- 2 Éclairage indirect  
Indirect lighting

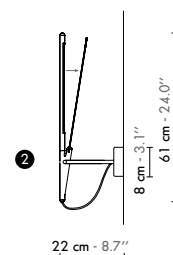
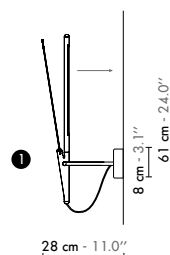



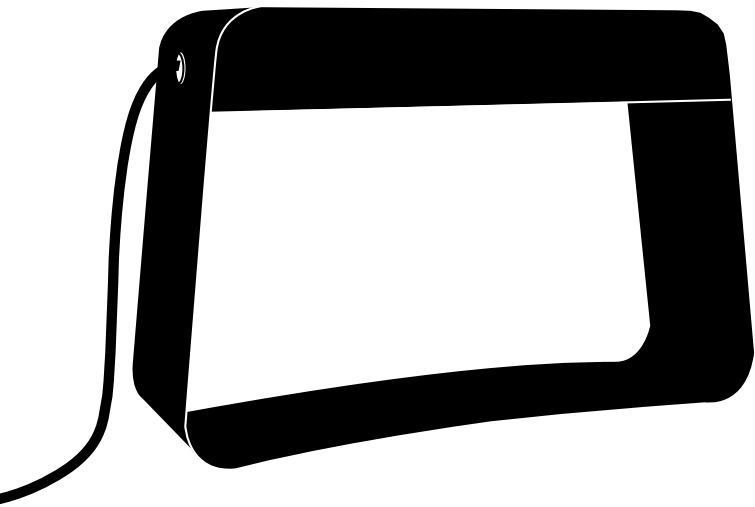

# Eau de Lumière

Daide Oppizzi



**Eau de Lumière**, un hommage au monde du parfum.

Créé par le designer Davide Oppizzi, le concept Eau de Lumière tire son histoire du monde du parfum de luxe. Du point de vue sculptural il s'agissait de symboliser la forme iconique de la bouteille de parfum pour en extraire une essence et une finesse, en jouant sur les volumes pleins et déliés sur lesquels renvoyer la lumière.

**Un luminaire pour ELLE et pour LUI** - Le design a été axé sur des formes masculines et féminines, en courbes ou en angles, de tailles différentes, utilisant des matières nobles telles que le bois, le marbre et le tissus pour en faire une collection complète et riche. Ses formes, matériaux et couleurs, permettent dans un même espace de garder un esprit homogène mais varié et à forte personnalité. Au sein de la famille de produits, la collection est déclinée en quatre formes et plusieurs tailles."

" **Eau de Lumière**, a tribute to the perfume world.

Designed by Davide Oppizzi, the Eau de Lumière concept takes its inspiration from the world of luxury perfume. Sculpturally, it symbolizes the iconic shape of perfume bottle, in effect extracting an essence and delicacy as evidenced by its full volume and hairlines, which reflect light.

**A light for HER and HIM** - Eau de Lumière takes from both masculine and feminine forms. Curves and angles are matched together using noble materials such as wood, marble and fabric to make a complete and rich collection. The shapes, materials and colors allow the collection to keep a homogeneous, but varied, spirit and a strong personality. There are several shapes and sizes within the family of products."

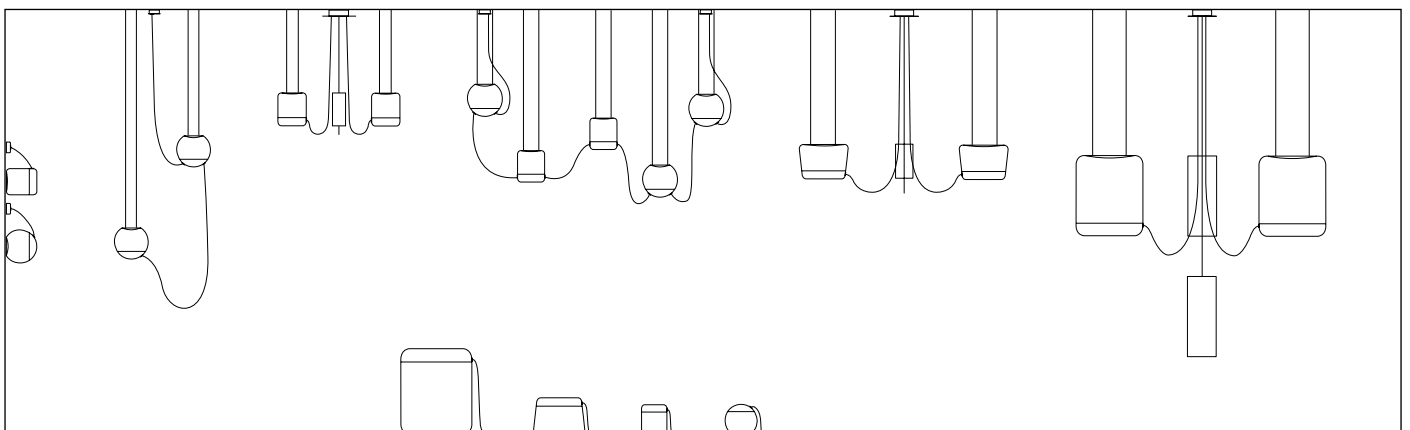

Versions disponibles / Available models





# Collection Eau de Lumière

Design : Davide Oppizzi

## Lampadaire 1 Grand Carré Eau de Lumière

## Lampe à poser 2 Moyen Rectangle Eau de Lumière

# Eau de Lumière

DaVIDE Oppizzi

## Lampe à poser 3 Petit Carré Eau de Lumière

## Lampe à poser 4 Petit Rond Eau de Lumière



Disponibles en trois tailles, et quatre formes, ces lampes LED procurent une agréable lumière, rétro-éclairant la couleur intérieure.

Finition au choix en véritable bois de chêne ou marbre blanc de Carrare."

"Available in three sizes and four shapes, these LED lamps provide a pleasant light, back-lighting the interior color.

Available in real oak wood or white Carrare marble finish."

<b>1</b> Lampadaire Grand C Large Ref : Lgcedl	L. 56 x l. 24 x H. 66 cm - Fil textile/Textile cord 2 m/6.6' 18 W - 230 V/120 V - 3000 K - IRC > 80 - Variateur/On-off switch Integrated LED
<b>2</b> Lampe Moyen R Medium Ref : Lmredl	L. 40 x l. 14 x H. 28 cm - Fil textile/Textile cord 2 m/6.6' 12 W - 230 V/120 V - 3000 K - IRC > 80 - Variateur/On-off switch Integrated LED
<b>3</b> Lampe Petit C Small Ref : Lpcedl	L. 21 x l. 9 x H. 23 cm - Fil textile/Textile cord 2 m/6.6' 6 W - 230 V/120 V - 3000 K - IRC > 80 - Variateur/On-off switch Integrated LED
<b>4</b> Lampe Petit R Small Ref : Lpredl	L. 25 x l. 9 x H. 23 cm - Fil textile/Textile cord 2 m/6.6' 6 W - 230 V/120 V - 3000 K - IRC > 80 - Variateur/On-off switch Integrated LED
Finitions/ Finishes	Voir page 143-149/See page 143-149
Matériaux Materials	Tissus, marbre blanc de Carrare ou chêne massif, fil tissé coloré. Fabric, white marble of Carrare or solid oak, colored textile cord.

MADE IN  
FRANCE

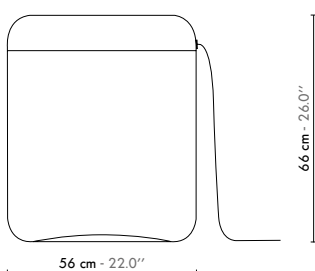

**1** Ref : Lgcedl

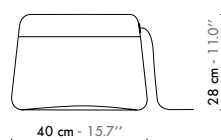

**2** Ref : Lmredl

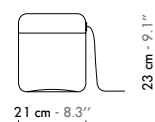

**3** Ref : Lpcedl

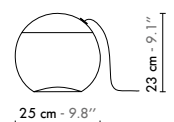

**4** Ref : Lpredl







# Eau de Lumière

DaVIDE Oppizzi

## Applique 1 Petit Carré Eau de Lumière

## Applique 2 Petit Rond Eau de Lumière



Les appliques peuvent être installées verticalement ou horizontalement, selon l'esthétique recherchée ou la distance avec la sortie électrique.

Finition au choix en véritable bois de chêne ou marbre blanc de Carrare."

"The sconce version can be installed vertically or horizontally according to the required esthetics or wiring demands.

Available in real oak wood or white Carrare marble finish."

<b>1</b> Applique Petit C Small Ref : Apcedl	L. 21 x l. 9 x H. 21 cm - Fil textile/Textile cord 0,5 m/1.6' 6 W - 230 V/120 V - 3000 K - IRC > 80	Integrated LED
<b>2</b> Applique Petit R Small Ref : Aprecl	L. 23 x l. 9 x H. 25 cm - Fil textile/Textile cord 0,5 m/1.6' 6 W - 230 V/120 V - 3000 K - IRC > 80	Integrated LED
Finitions/ Finishes	Voir page 143-149/See page 143-149	
Matériaux Materials	Tissus, marbre blanc de Carrare ou chêne massif, fil tissé coloré. Fabric, white marble of Carrare or solid oak, colored textile cord.	

MADE IN FRANCE

\* **1 2** Au choix :

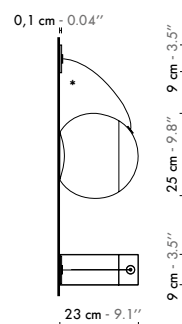
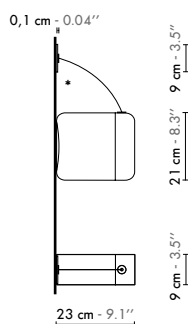
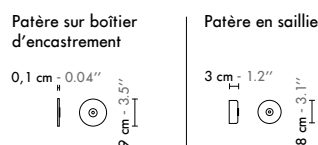

**1** Ref : Apcedl

**2** Ref : Aprecl



2



1

# Eau de Lumière

Daide Oppizzi

## Suspension 2 ■ Petit Carré Eau de Lumière

## Suspension 2 ■ Petit Rond Eau de Lumière



Comme une installation poétique, cette suspension réglable apporte une sensation de lumière en lévitation.

Disponible en deux petites formes, carrées et rondes, montées en séries.

Finition au choix en véritable bois de chêne ou marbre blanc de Carrare."

"As a poetic installation, this adjustable suspension light brings a sensation of levitation.

Two small shapes--either square or circle--are connected in a series.

Available in real oak wood or white Carrare marble finish."

- 1 Suspension 2  
Petit C  
Small  
Ref : S2pcedl

Hauteur sous plafond de 2,5 à 4 m / Ceiling height from 8' to 13'  
L. 21 x l. 9 x H. 23 cm - Fil textile / Textile cord 2 / 1,50 m / 6.6' / 4.9' - Câble acier / Steel cable 4 x 2 m / 4 x 6.6' - 2 x 6 W - 230 V / 120 V - 3000 K - IRC > 80

Integrated LED CE EAC ETL 850° IP 20

- 2 Suspension 2  
Petit R  
Small  
Ref : S2predl

Hauteur sous plafond de 2,5 à 4 m / Ceiling height from 8' to 13'  
L. 25 x l. 9 x H. 23 cm - Fil textile / Textile cord 2 / 1,50 m / 6.6' / 4.9' - Câble acier / Steel cable 4 x 2 m / 4 x 6.6' - 2 x 6 W - 230 V / 120 V - 3000 K - IRC > 80

Integrated LED CE EAC ETL 850° IP 20

Finitions/  
Finishes

Voir page 143-149 / See page 143-149

Matériaux  
Materials

Tissu, marbre blanc de Carrare ou chêne massif, fil tissé coloré.  
Fabric, white marble of Carrare or solid oak, colored textile cord.

MADE IN  
FRANCE

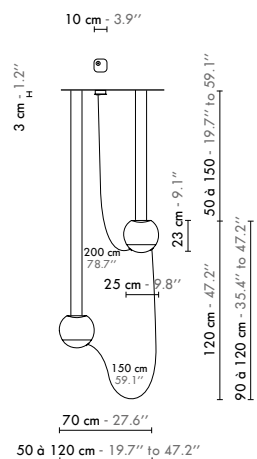
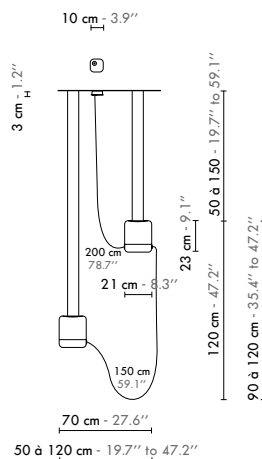

1 Ref : S2pcedl



2 Ref : S2predl





2

# Eau de Lumière

Daide Oppizzi

## Suspension 5 ■ Petit Eau de Lumière



Suspension poétique réglable à installer en scénographie murale ou au dessus d'une table, créant un chemin lumineux.

Disponible en deux petites formes combinées, carrées et rondes, montées en séries. Suspension réglable en hauteur et largeur.

Finition au choix en véritable bois de chêne ou marbre blanc de Carrare."

"The adjustable, expanded suspension configuration can be installed as a bright and poetic wall scenography, either as a table runner.

Combined in two small shapes, square and circle, they are connected in series. Adjustable height and width.

Available in real oak wood or white Carrare marble finish."

■ Suspension 5  
Petit  
Small  
Ref : S5pedl

Hauteur sous plafond de 3 à 4 m / Ceiling height from 10' to 13'

Abj/Ls : carré/square L. 21 x l. 9 x H. 23 cm

Abj Rond/Round L. 25 x l. 9 x H. 23 cm - Fil textile/Textile cord 2 x 2 m/2

x 6.6' - Câble acier/Steel cable 10 x 2 m/10 x 6.6'

5 x 6 W - 230 V/120 V - 3000 K - IRC > 80

Integrated LED

Finitions/  
Finishes

Voir page 143-149/See page 143-149

Matériaux  
Materials

Tissus, marbre blanc de Carrare ou chêne massif, fil tissé coloré.  
Fabric, white marble of Carrare or solid oak, colored textile cord.

MADE IN  
FRANCE

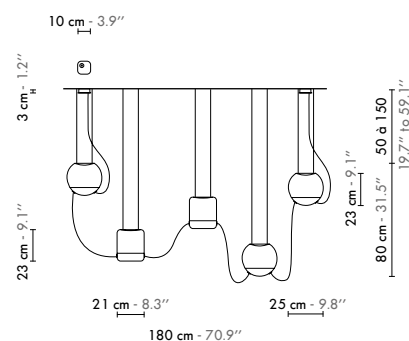

■ Ref : S5pedl



1



# Eau de Lumière

DaVIDE Oppizzi

## Lustre 4 ■ Petit Carré Eau de Lumière

## Lustre 4 ■ Petit Rond Eau de Lumière



Disponibles en petit carré et petit rond, en forme de lustre classique avec une alimentation centrale.

Lustre réglable en hauteur et largeur.

Finition au choix en véritable bois de chêne ou marbre blanc de Carrare."

" Available in small square or small circle shapes, mounted as a classical chandelier with central power supply.

Adjustable height and width.

Available in real oak wood or white Carrare marble finish."

- 1 Lustre 4  
Petit Carré  
Small  
Ref : Lu4pcedl

Hauteur sous plafond de 2,70 à 3,50 m / Ceiling height from 9' to 12'  
Ø 96 cm x H. 100 cm - Abj/Ls : L. 21 x l. 9 x H. 23 cm -  
Fil textile / Textile cord 4 x 1,15 m / 4 x 3.8' - Câble acier / Steel cable  
8 x 2 m / 8 x 6.6' - 4 x 6 W - 230 V / 120 V - 3000 K - IRC > 80

Integrated LED

- 2 Lustre 4  
Petit Rond  
Small  
Ref : Lu4predl

Hauteur sous plafond de 2,70 à 3,50 m / Ceiling height from 9' to 12'  
Ø 100 cm x H. 100 cm - Abj/Ls : L. 25 x l. 9 x H. 23 cm -  
Fil textile / Textile cord 4 x 1,15 m / 4 x 3.8' - Câble acier / Steel cable  
8 x 2 m / 8 x 6.6' - 4 x 6 W - 230 V / 120 V - 3000 K - IRC > 80

Integrated LED

Finitions/  
Finishes

Voir page 143-149 / See page 143-149

Matériaux  
Materials

Tissus, marbre blanc de Carrare ou chêne massif, fil tissé coloré.  
Fabric, white marble of Carrare or solid oak, colored textile cord.

MADE IN  
FRANCE

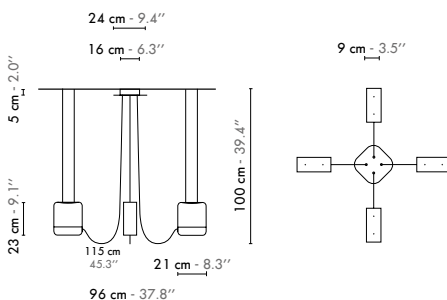

1 Ref : Lu4pcedl

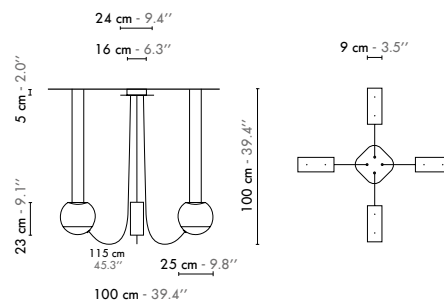

2 Ref : Lu4predl



# Eau de Lumière

DaVIDE Oppizzi

## Lustre 4 ■ Moyen Rectangle Eau de Lumière



Disponibles en moyen rectangle, en forme de lustre classique avec une alimentation centrale.

Lustre réglable en hauteur et largeur.

La version rectangulaire est particulièrement recommandée pour figurer au dessus d'une table. Finition au choix en véritable bois de chêne ou marbre blanc de Carrare."

" Available in medium rectangle, shaped as a classical chandelier with central power supply.

Adjustable height and width.

This rectangular configuration is particularly recommended above a table.

Available in real oak wood or white Carrare marble finish."

■ Lustre 4  
Moyen R  
Medium  
Ref : Lu4mredl

Hauteur sous plafond de 3 à 4 m / Ceiling height from 10' to 13'  
Ø 160 cm x H. 150 cm - Abj./Ls : L. 40 x l. 14 x H. 28 cm - Fil textile / Textile cord 4 x 1,9 m / 4 x 6.2' - Câble acier / Steel cable 8 x 2 m / 8 x 6.6' 4 x 12 W - 230 V / 120 V 3000 K - IRC > 80

Integrated LED

Finitions/  
Finishes

Voir page 143-149 / See page 143-149

Matériaux  
Materials

Tissus, marbre blanc de Carrare ou chêne massif, fil tissé coloré.  
Fabric, white marble of Carrare or solid oak, colored textile cord.

MADE IN FRANCE

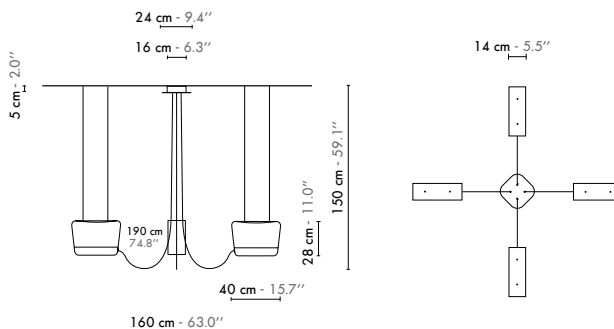

■ Ref : Lu4mredl





# Eau de Lumière

Daide Oppizzi

## Lustre 4 ■ Grand Carré Eau de Lumière



Disponibles en grand carré, en forme de lustre classique avec une alimentation centrale. Lustre réglable en hauteur et largeur.

Proposé ici avec un élément dissocié vers le bas, il peut sur demande être monté en configuration symétrique.

Cette configuration est particulièrement recommandée pour le lobby en hôtellerie.

Finition au choix en véritable bois de chêne ou marbre blanc de Carrare."

" Available in large square, shaped as a classical chandelier with central power supply. Adjustable height and width.

The version proposed here includes a separated downward element that can be mounted in symmetrical configuration on demand.

This configuration is particularly recommended for hotel lobbies.

Available in real oak wood or white Carrare marble finish."

■ Lustre 4  
Grand Carré  
Large  
Ref : Lu4gcedl

Hauteur sous plafond de 4,5 à 6 m / Ceiling height from 15' to 20'  
Ø 205 cm x H. 275 cm - Abj./Ls : L. 56 x l. 24 x H. 66 cm - Fil textile / Tex-  
tile cord 4 x 2,7 m / 4 x 8.9' - Câble acier / Steel cable 2 x 3 m + 6 x 2 m /  
2 x 9.8' + 6 x 6.6' - 4 x 18 W - 230 V / 120 V - 3000 K - IRC > 80

Integrated LED

Finitions/  
Finishes Voir page 143-149 / See page 143-149

Matériaux  
Materials Tissus, marbre blanc de Carrare ou chêne massif, fil tissé coloré.  
Fabric, white marble of Carrare or solid oak, colored textile cord.

MADE IN  
FRANCE

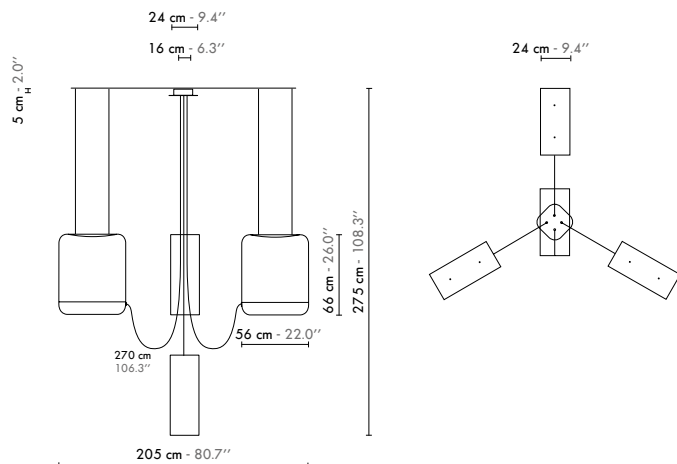

■ Ref : Lu4gcedl





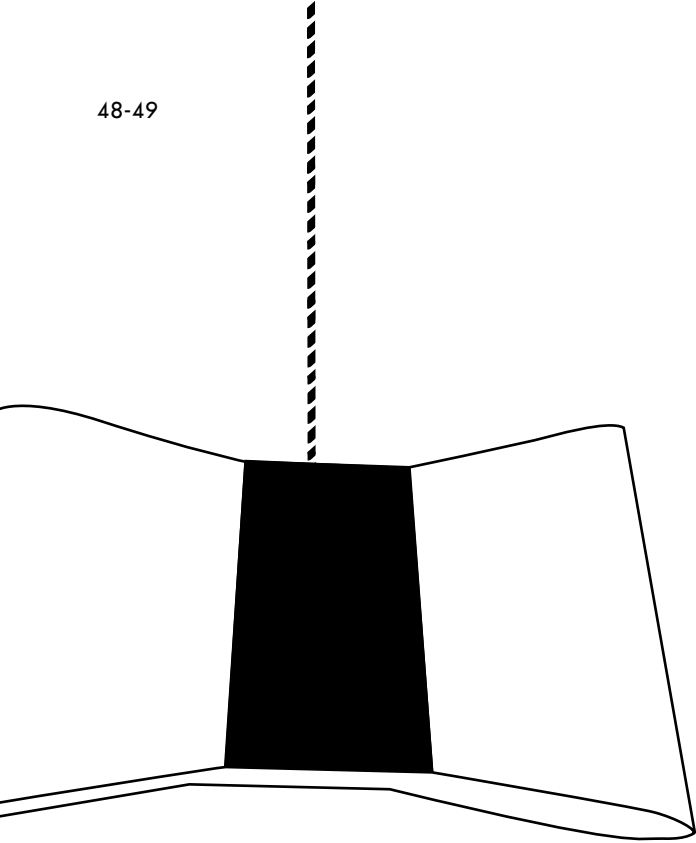

# Couture

Emmanuelle Legavre



Chic et décalé, le nœud papillon est masculin autant que féminin ! C'est l'accessoire typiquement dandy, le reflet d'une allure élégante et osée... avec un petit grain de folie. Emmanuelle Legavre s'en inspire et signe pour Designheure, **Couture**, sa toute dernière collection de luminaires, véritable clin d'oeil à cet incontournable accessoire de mode.

Pimpante et stylée, la collection Couture habille tous les espaces avec panache et raffinement et nous montre à quel point la frontière entre la mode et le design est très souvent ténue."

"Chic and quirky, the bow tie is a quintessential dandy fashion accessory—a reflection of an elegant and daring look, with a touch of whimsy.

Acknowledging this fashion sensibility, Emmanuelle Legavre has created her latest collection, **Couture**, for Designheure. Stylish and staggered, the collection dresses up spaces with elegant panache and shows that the boundary between fashion and design is very often a myth."

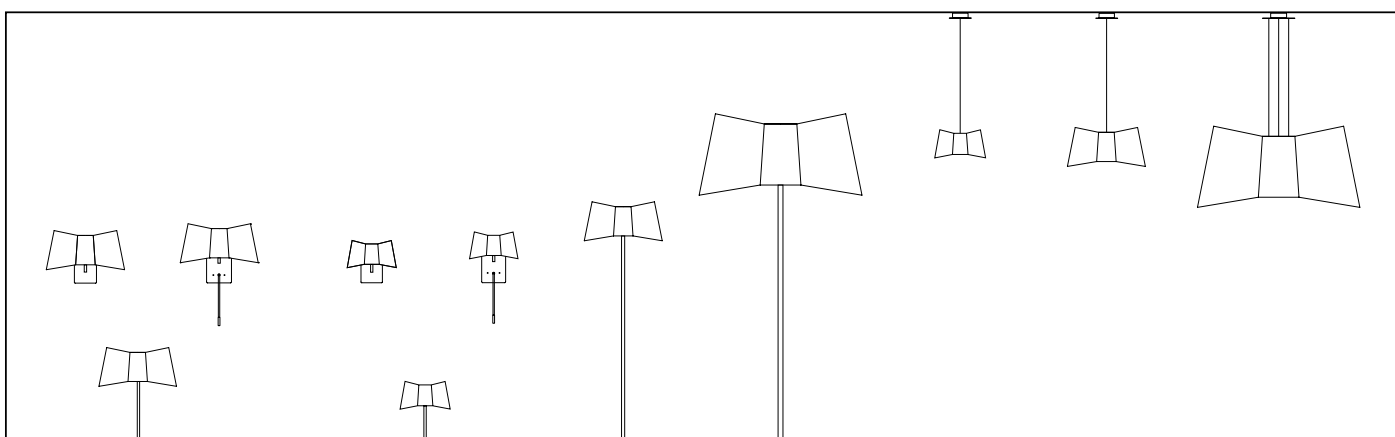



# Collection Couture

Design : Emmanuelle Legavre

# Couture

Emmanuelle Legavre

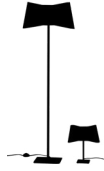

## Lampadaire ■ Grand Couture













## Lampe à poser ■ Grand Couture

## Lampe à poser ■ Petit Couture



Existe en deux tailles de lampes et lampadaires et en trois coloris.”

“ Available in two sizes of either table or floor lamps and three colors. ”

<b>1</b> Lampadaire Grand Couture Large Ref : L154gct	L. 50 x l. 25 x H. 154 cm - Abj/Ls : L. 50 x l. 18 x H. 25 cm - Fil textile/ Textile cord 2 m/6.6' - 1 x Max 60 W - 230 V : E27 - 120 V : E26 Ø max 70 mm/bulb Ø max 2.8" - Non fournie/Not incl.	     
<b>2</b> Lampe Grand Couture Large Ref : L60gct	L. 50 x l. 20 x H. 60 cm - Abj/Ls : L. 50 x l. 18 x H. 25 cm - Fil textile/ Textile cord 2 m/6.6' - 1 x Max 60 W - 230 V : E27 - 120 V : E26 Ø max 70 mm/bulb Ø max 2.8" - Non fournie/Not incl.	     
<b>3</b> Lampe Petit Couture Small Ref : L39pct	L. 32 x l. 14 x H. 39 cm - Abj/Ls : L. 32 x l. 14 x H. 17 cm - Fil textile/ Textile cord 2 m/6.6' - 1 x Max 40 W - 230 V : E27 - 120 V : E26 Ø max 60 mm et H. max 110 mm/bulb Ø max 2.4" and MOL 4.3" Non fournie/Not incl.	     
Finitions/ Finishes	Voir page 143-149/See page 143-149	
Matériaux Materials	Tissus, acier laqué, fil tissé coloré. Fabric, lacquered steel, colored textile cord.	

MADE IN  
FRANCE



**1** Ref : L154gct

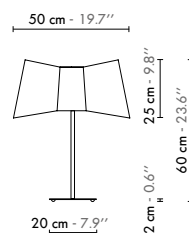

**2** Ref : L60gct

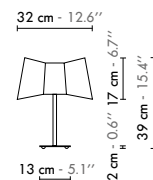

**3** Ref : L39pct



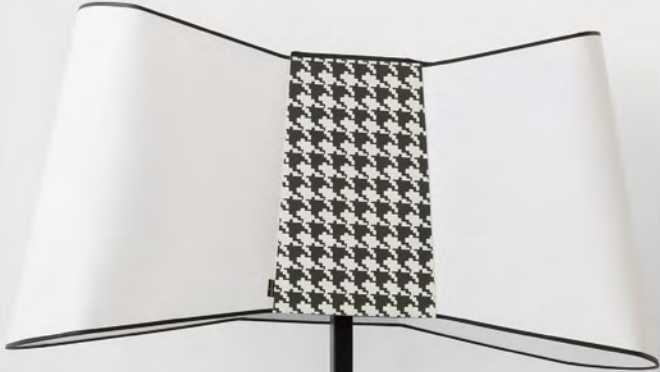

2

3

1

# Couture

Emmanuelle Legavre

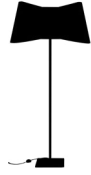

## Lampadaire ■ XXL Couture



Très grand lampadaire ultra chic, disponible en trois coloris, tous bordés de noir."

" This large and chic floor lamp is available in three colors, all rimmed with a black border. "

■ Lampadaire  
XXL Couture  
Ref : Lxxlct

L. 100 x l. 36 x H. 200 cm - Abj/Ls : L. 100 x l. 36 x H. 50 cm - Fil textile/  
Textile cord 2 m/6.6'' - 2 x Max 60 W - 230 V : E27 - 120 V : E26 - Non  
fournie/Not incl.



Finitions/  
Finishes

Voir page 143-149/See page 143-149

Matériaux  
Materials

Tissus, acier laqué, fil tissé coloré.  
Fabric, lacquered steel, colored textile cord.

MADE IN  
FRANCE

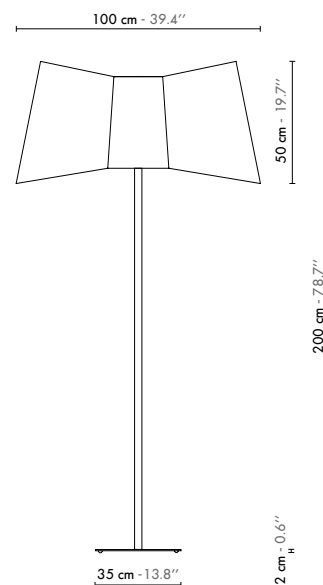





# Couture

Emmanuelle Legavre



Disponibles en deux modèles, deux tailles et trois coloris.

Les appliques en version LED, très élégantes, offrent une double source lumineuse : ampoule et liseuse LED. Leur double interrupteur est particulièrement recommandé pour une lecture confortable avec ou sans l'éclairage de la lampe principale."

"Available in two models, two sizes and three colors.

























The stylish LED version offer a double light source of a bulb and LED reading light. Its double switch is particularly recommended for comfortable viewing with or without the need to light the main lamp."

## Applique Grand Couture 1

## Applique Petit Couture 2

## Applique liseuse LED Grand Couture 3

## Applique liseuse LED Petit Couture 4

<b>1</b> Applique Grand Couture Large Ref : A32gct	L. 50 x l. 21 x H. 32 cm - Abj/Ls : L. 50 x l. 18 x H. 25 cm 1 x Max 60 W - 230 V : E27 - 120 V : E26 - Ø max 70 mm/bulb Ø max 2.8" - Non fournie/Not incl.	     850° 
<b>2</b> Applique Petit Couture Small Ref : A26pct	L. 32 x l. 19 x H. 26 cm - Abj/Ls : L. 32 x l. 14 x H. 17 cm 1 x Max 40 W - 230 V : E27 - 120 V : E26 - Ø max 60 mm et H. max 110 mm/bulb Ø max 2.4" and MOL 4.3" - Non fournie/Not incl.	     850° 
<b>3</b> Applique LED Grand Couture Large Ref : A38gctled	L. 50 x l. 21 x H. 38 cm - Abj/Ls : L. 50 x l. 18 x H. 25 cm LED 1W + 1 x Max 40 W - 230 V : E27 - 120 V : E26 - Ø max 70 mm/bulb Ø max 2.8" - Non fournie/Not incl.	     850° 
<b>4</b> Applique LED Petit Couture Small Ref : A33pctled	L. 32 x l. 19 x H. 33 cm - Abj/Ls : L. 32 x l. 14 x H. 17 cm LED 1W + 1 x Max 40 W - 230 V : E27 - 120 V : E26 - Ø max 60 mm et H. max 110 mm /bulb Ø max 2.4" and MOL 4.3" - Non fournie/Not incl.	     850° 
Finitions/ Finishes	Voir page 143-149/See page 143-149	
Matériaux Materials	Tissus, acier laqué. Fabric, lacquered steel.	

MADE IN FRANCE

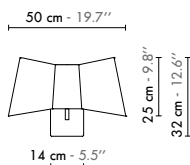

1 Ref : A32gct

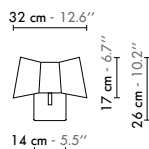

2 Ref : A26pct

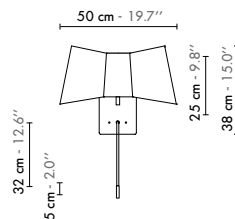

3 Ref : A38gctled

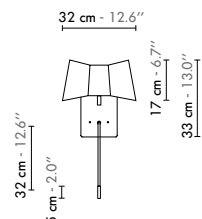

4 Ref : A33pctled

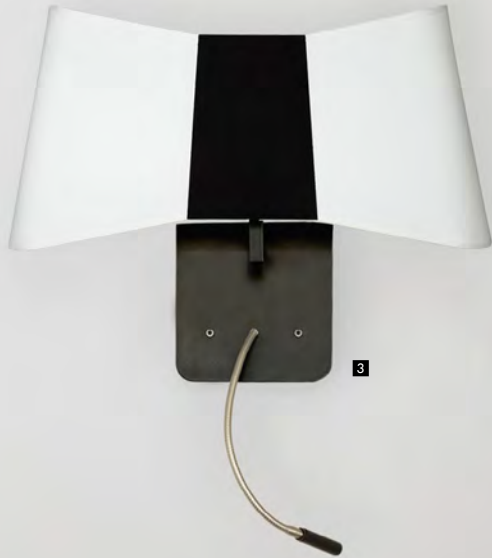

**Couture**   
Emmanuelle Legavre













**Suspension 1**  
**Grand Couture**

**Suspension 2**  
**Petit Couture**



Disponibles en trois tailles et trois coloris."

" Available in three sizes and three colors. "

<b>1</b> Suspension Grand Couture Large Ref : S25gct	Abj/Ls : L. 50 x l. 18 x H. 25 cm - Fil textile/Textile cord 2 m/6.6' 1 x Max 60 W - 230 V : E27 - 120 V : E26 - Ø max 70 mm/bulb Ø max 2.8" - Non fournie/Not incl.	     850° 
<b>2</b> Suspension Petit Couture Small Ref : S17pct	Abj/Ls : L. 32 x l. 14 x H. 17 cm - Fil textile/Textile cord 2 m/6.6' 1 x Max 40 W - 230 V : E27 - 120 V : E26 - Ø max 60 mm et H. max 110 mm /bulb Ø max 2.4" and MOL 4.3" - Non fournie/Not incl.	     850° 
Finitions/ Finishes	Voir page 143-149/See page 143-149	
Matériaux Materials	Tissus, acier laqué, fil tissé coloré. Calico fabric, lacquered steel, colored textile cord.	

**MADE IN  
FRANCE**

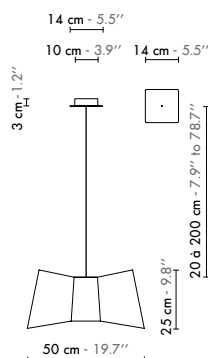

**1** Ref : S25gct

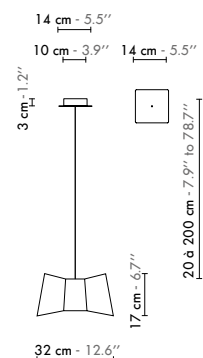

**2** Ref : S17pct





1



2



# Couture

Emmanuelle Legavre



## Suspension ■ XXL Couture

//

Très grande suspension équipée d'un diffuseur inférieur en polycarbonate.

Disponible en trois coloris, tous bordés de noir."

"Oversized suspended light equipped with a lower diffuser in polycarbonate.

Available in three colors, all rimmed with a black border."

### ■ Suspension XXL Couture

Ref : Sxxlct

Abj/Ls : L. 100 x l. 36 x H. 50 cm - Fil textile/Textile cord 2 m/6.6' -  
Câble acier/Steel cable 2 x 2 m/2 x 6.6' - 2 x Max 60 W - 230 V : E27  
- 120 V : E26 - Non fournie/Not incl.



Finitions/  
Finishes

Voir page 143-149/See page 143-149

Matériaux  
Materials

Tissus, acier laqué, fil tissé coloré  
Fabric, lacquered steel, colored textile cord.

MADE IN  
FRANCE

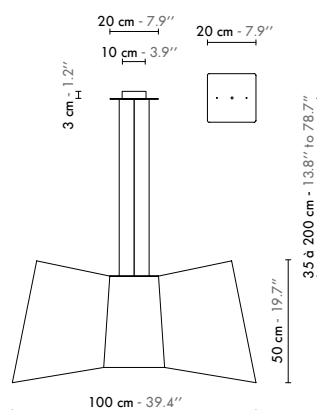

■ Ref : Sxxlct





# Nénuphar

Kristian Gavaille

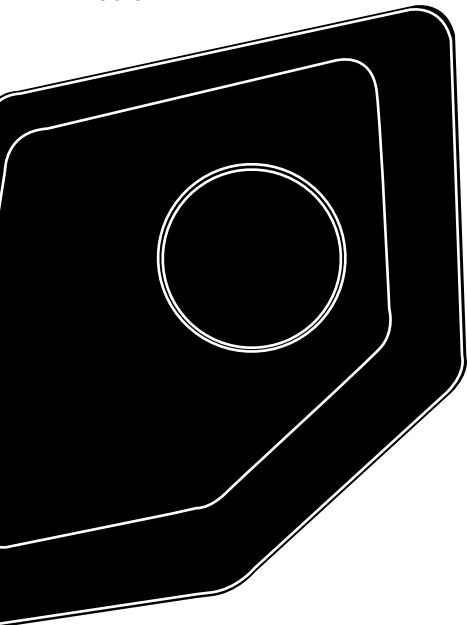

Véritable sculpture lumineuse, **Nénuphar** habille de manière fascinante les murs et les plafonds jouant tout à la fois le rôle d'une sculpture, d'un mur acoustique et d'un luminaire. Son choix de coloris sur mesure et son caractère modulable et orientable à 360°, laissent une grande part de créativité à l'utilisateur.

Il est doté d'une source lumineuse LED discrète et vecteur de modernité diffusant la lumière en rétroéclairage indirect. Il constitue une réponse à la double problématique des grands espaces muraux dans les lobbys d'hôtels et / ou des plafonds très bas donnant sur de grands espaces et nécessitant une réponse décorative architecturale. Nénuphar est disponible en appliques, plafonniers et suspensions réglables, en version simple ou en trio, pour composer librement sa scénographie avec un, deux, trois modèles ou à l'infini."

" A genuine light sculpture, **Nénuphar** indirect LED lights illuminate surrounding walls and ceilings in a fascinating way. At the same time, it functions as a visually arresting design element and sound panel.

The design's customizable colors and modular nature—it can be hung from any angle—allows for significant creative license. It is also well suited to address large wall spacings and low ceilings overlooking areas that require decorative and architectural flourishes—think a hotel lobby or connecting hallways.

Nénuphar is available in several configurations including wall lights, ceiling lights and adjustable suspended lights. It can be used as a single unit, a trio or any number of combinations that meet a space's needs."

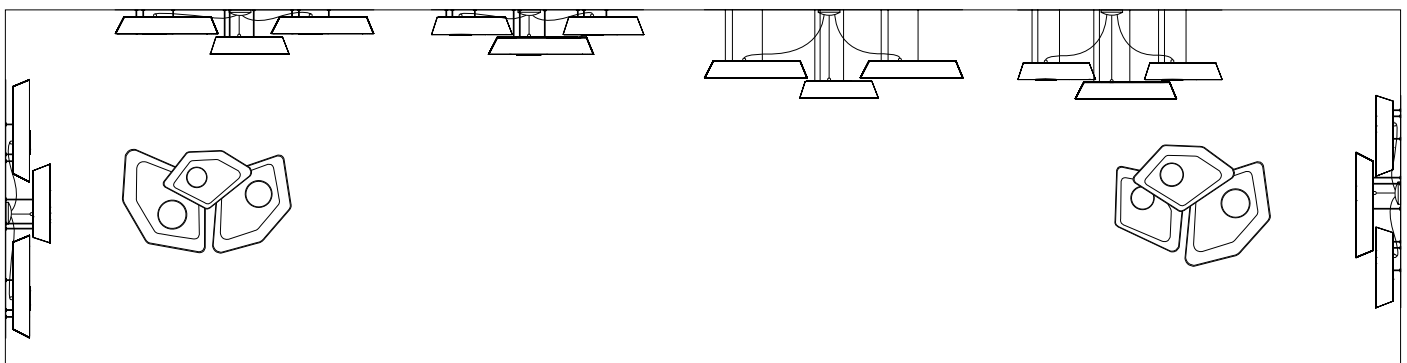
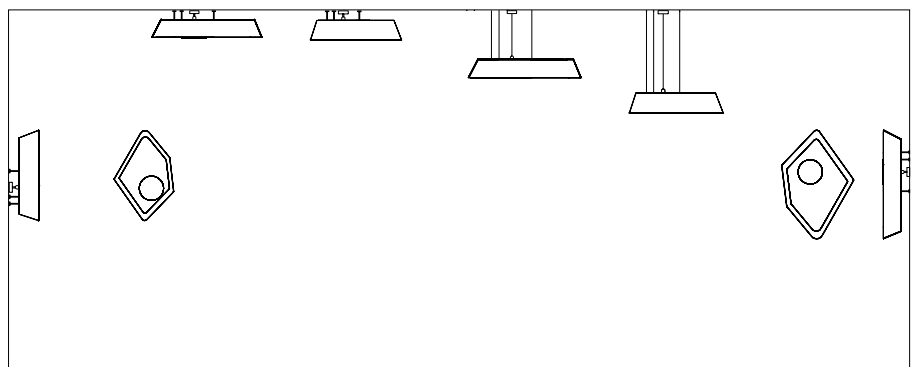

Versions disponibles / Available models



# Collection Nénuphar

Design : Kristian Gavaille

# Nénuphar

Kristian Gavaille



## Applique Trio Grand Nénuphar LED 1 Applique Trio Petit Nénuphar LED 2

## Applique Grand Nénuphar LED 3 Applique Petit Nénuphar LED 4



Proposé avec deux ensembles de petites tiges fixes et un ensemble de grandes tiges, ce modèle trio permet une mise en perspective de l'une des appliques lors de l'installation.

L'alimentation des trois abat-jour est regroupée dans un boîtier unique de connexion électrique. L'applique simple est fournie avec les petites tiges de fixation."

" The Trio model's multilayered rods allows for one segment to rest 'above' which creates perspective. A single electrical current ties the three together and minimizes wiring.

Single wall lamps are provided with a small mounting rod."

<b>1</b> Applique Trio Grand Nénuphar Large Ref: A2g1gnled	L. min 150 x l. 50 x H. min 120 cm - Abj/Ls : 2 x L. 118 x l. 78 x H. 19 cm + 1 x L. 90 x l. 61 x H. 19 cm - Fil textile/Textile cord 3 x 1 m/3 x 3.3' 3 x 18 W - 230/120 V - 3000 K - IRC > 90 Integrated LED      850°
<b>2</b> Applique Trio Petit Nénuphar Small Ref: A2p1gnled	L. min 140 x l. 50 x H. min 110 cm - Abj/Ls : 2 x L. 90 x l. 61 x H. 19 cm + 1 x L. 118 x l. 78 x H. 19 cm - Fil textile/Textile cord 3 x 1 m/3 x 3.3' 3 x 18 W - 230/120 V - 3000 K - IRC > 90 Integrated LED      850°
<b>3</b> Applique Grand Nénuphar Large Ref: A118nled	L. 118 x l. 78 x H. 27 cm - Abj/Ls : L. 118 x l. 78 x H. 19 cm 18 W - 230/120 V - 3000 K - IRC > 90 Integrated LED      850°
<b>4</b> Applique Petit Nénuphar Small Ref: A90nled	L. 90 x l. 61 x H. 27 cm - Abj/Ls : L. 90 x l. 61 x H. 19 cm 18 W - 230/120 V - 3000 K - IRC > 90 Integrated LED      850°
Finitions /Finishes	Voir page 143-149/See page 143-149
Matériaux /Materials	Tissus, acier thermolaqué, fil tissé coloré. Fabric, lacquered steel, colored textile cord.

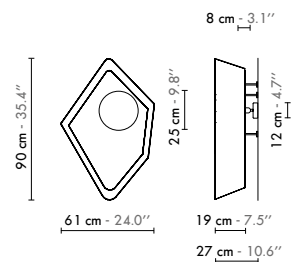
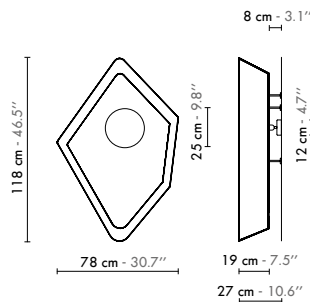
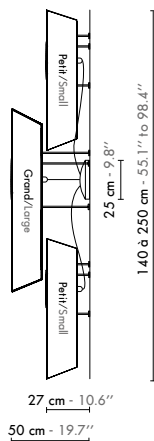
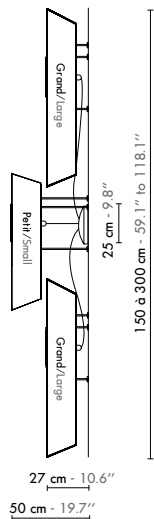

1 Ref: A2g1gnled



2 Ref: A2p1gnled

3 Ref: A118nled

4 Ref: A90nled



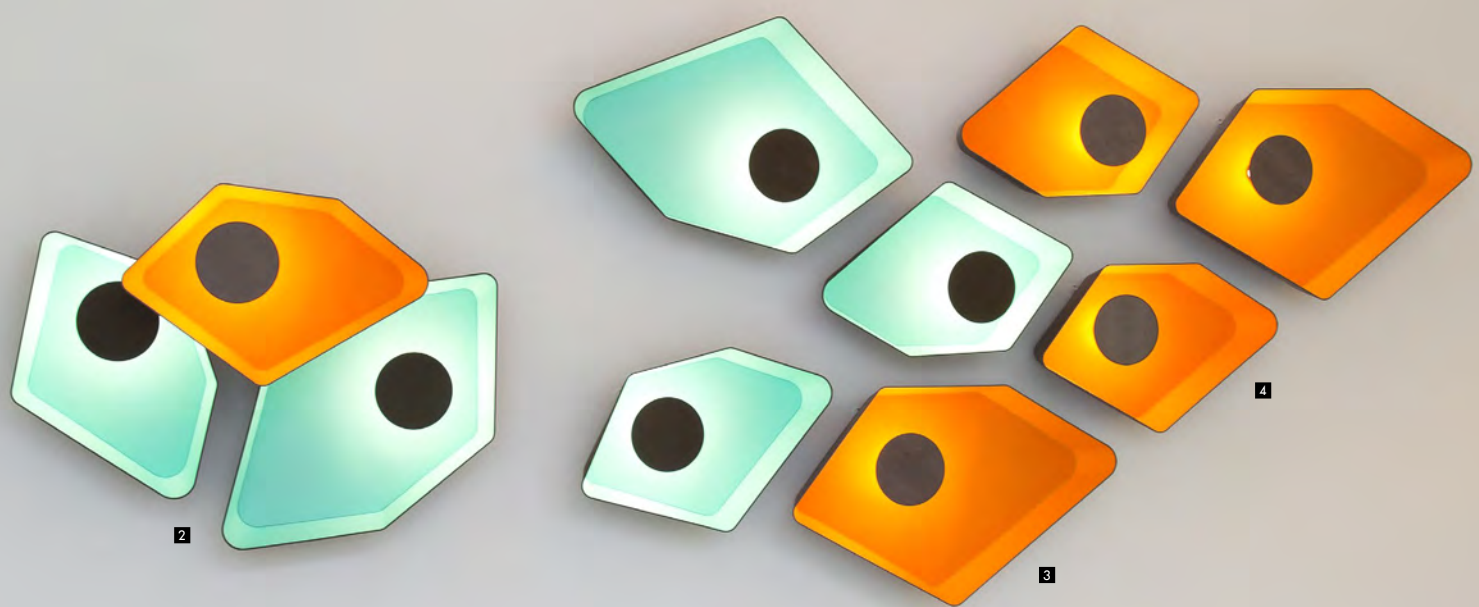

# Nénuphar

Kristian Gavaille



## Suspension Trio Grand Nénuphar LED 1 Suspension Trio Petit Nénuphar LED 2

## Suspension Grand Nénuphar LED 3 Suspension Petit Nénuphar LED 4



Ses câbles réglables permettront d'en définir la hauteur pour une parfaite adaptation à l'espace.

Une seule connexion électrique dans un boîtier principal regroupe les 3 lampes du modèle Trio."

" The adjustable cables of the Nénuphar's pendant light adapt to fit perfectly within any space.

In the Trio model, a single electrical connection in the main supply junction box connects the three lamps."

<b>1</b> Suspension Trio Grand Nénuphar Large Ref : S2g1pnled	<b>Hauteur sous plafond min 2,7 m/Ceiling height min 9'</b> L. min 150 x l. min 120 x H. min 50 cm - Abj/Ls : 2 x L. 118 x l. 78 x H. 19 cm + 1 x L. 90 x l. 61 x H. 19 cm - Fil textile & Câble acier/Textile cord & Steel cable 9 x 2 m/9 x 6.6' - 3 x 18 W - 230 V/120 V - 3000 K - IRC > 90
Integrated LED       850°	
<b>2</b> Suspension Trio Petit Nénuphar Small Ref : S2p1gnled	<b>Hauteur sous plafond min 2,7 m/Ceiling height min 9'</b> L. min 140 x l. min 110 x H. min 50 cm - Abj/Ls : 2 x L. 90 x l. 61 x H. 19 cm + 1 x L. 118 x l. 78 x H. 19 cm - Fil textile & Câble acier/Textile cord & Steel cable 9 x 2 m/9 x 6.6' - 3 x 18 W - 230 V/120 V - 3000 K - IRC > 90
Integrated LED       850°	
<b>3</b> Suspension Grand Nénuphar Large Ref : S118nled	<b>Hauteur sous plafond min 2,5 m/Ceiling height min 8'</b> L. 118 x l. 78 x H. min 27 cm - Abj/Ls : L. 118 x l. 78 x H. 19 cm - Fil textile & Câble acier/Textile cord & Steel cable 2 m/6.6' - 18 W - 230 V/120 V - 3000 K - IRC > 90
Integrated LED       850°	
<b>4</b> Suspension Petit Nénuphar Small Ref : S90nled	<b>Hauteur sous plafond min 2,5 m/Ceiling height min 8'</b> L. 90 x l. 61 x H. min 27 cm - Abj/Ls : L. 90 x l. 61 x H. 19 cm - Fil textile & Câble acier/Textile cord & Steel cable 2 m/6.6' - 18 W - 230 V/120 V 3000 K - IRC > 90
Integrated LED       850°	
Finitions/ Finishes	Voir page 143-149/See page 143-149
Matériaux Materials	Tissus, acier thermolaqué, fil tissé coloré. Fabric, lacquered steel, colored textile cord.

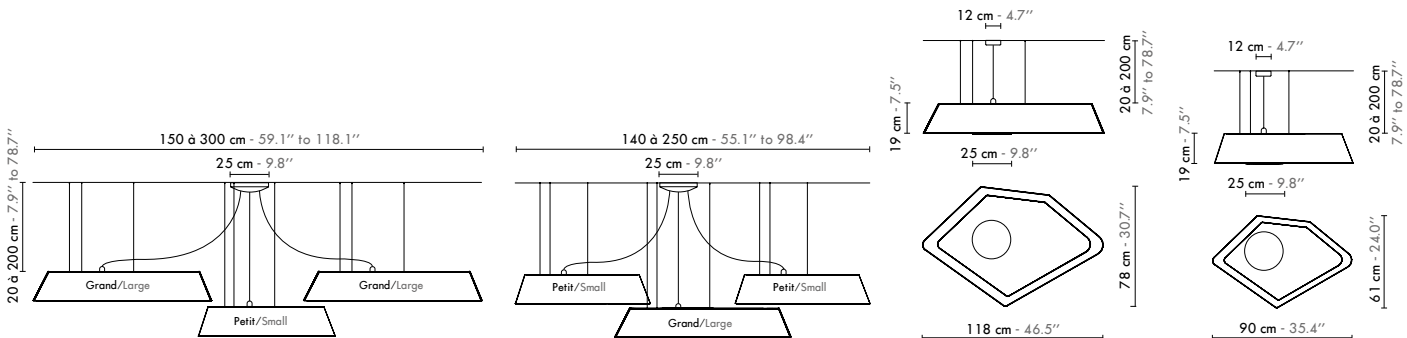

**1** Ref : S2g1pnled



**2** Ref : S2p1gnled



**3** Ref : S118nled



**4** Ref : S90nled





# Nénuphar

Kristian Gavaille



## Plafonnier Trio Grand Nénuphar LED 1 Plafonnier Trio Petit Nénuphar LED 2

## Plafonnier Grand Nénuphar LED 3 Plafonnier Petit Nénuphar LED 4



Le modèle Trio est proposé avec deux ensembles de petites tiges fixes et un ensemble de grandes tiges. Cet ensemble permet une mise en avant et en perspective de l'un des modèles, au choix lors de l'installation.

Une seule connexion électrique dans un boîtier principal regroupe les 3 lampes.

Le plafonnier simple est fourni avec les petites tiges de fixation."

"Similar to the wall sconce the ceiling mounted version of the Trio allows for one segment to rest 'below' which creates perspective.

A single electrical current ties the three together and minimizes wiring.

Single wall lamps are provided with a small mounting rod."

<b>1</b> Plafonnier Trio Grand Nénuphar Large Ref : Pl2g1pnled	Hauteur sous plafond min 2,7 m/Ceiling height min 9' L. min 150 x l. min 120 x H. 50 cm - Abj/Ls : 2 x L. 118 x l. 78 x H. 19 cm + 1 x L. 90 x l. 61 x H. 19 cm - Fil textile/Textile cord 3 x 1 m/3 x 3.3' 3 x 18 W - 230 V/120 V - 3000 K - IRC > 90 Integrated LED  850° IP 20
<b>2</b> Plafonnier Trio Petit Nénuphar Small Ref : Pl2p1gnled	Hauteur sous plafond min 2,7 m/Ceiling height min 9' L. min 140 x l. min 110 x H. 50 cm - Abj/Ls : 2 x L. 90 x l. 61 x H. 19 cm + 1 x L. 118 x l. 78 x H. 19 cm - Fil textile/Textile cord 3 x 1 m/3 x 3.3' 3 x 18 W - 230 V/120 V - 3000 K - IRC > 90 Integrated LED  850° IP 20
<b>3</b> Plafonnier Grand Nénuphar Large Ref : Pl118nled	Hauteur sous plafond min 2,5 m/Ceiling height min 8' L. 118 x l. 78 x H. 27 cm - Abj/Ls : L. 118 x l. 78 x H. 19 cm 18 W - 230 V/120 V - 3000 K - IRC > 90 Integrated LED  850° IP 20
<b>4</b> Plafonnier Petit Nénuphar Small Ref : Pl90nled	Hauteur sous plafond min 2,5 m/Ceiling height min 8' L. 90 x l. 61 x H. 27 cm - Abj/Ls : L. 90 x l. 61 x H. 19 cm 18 W - 230 V/120 V - 3000 K - IRC > 90 Integrated LED  850° IP 20
Finitions/ Finishes	Voir page 143-149/See page 143-149  Matériaux Materials
	Tissus, acier thermolaqué, fil tissé coloré. Fabric, lacquered steel, colored textile cord.

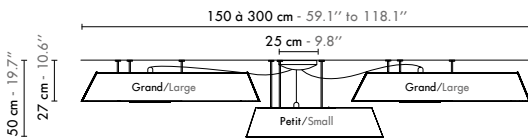

➔ **1** Ref : Pl2g1pnled

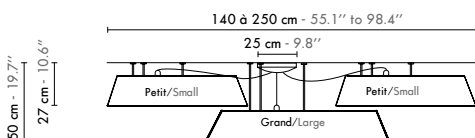

➔ **2** Ref : Pl2p1gnled

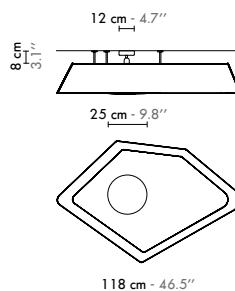

**3** Ref : Pl118nled

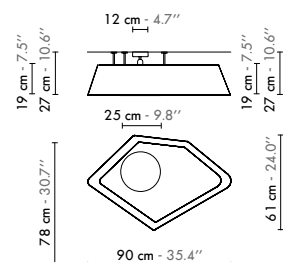

**4** Ref : Pl90nled



2

3

4

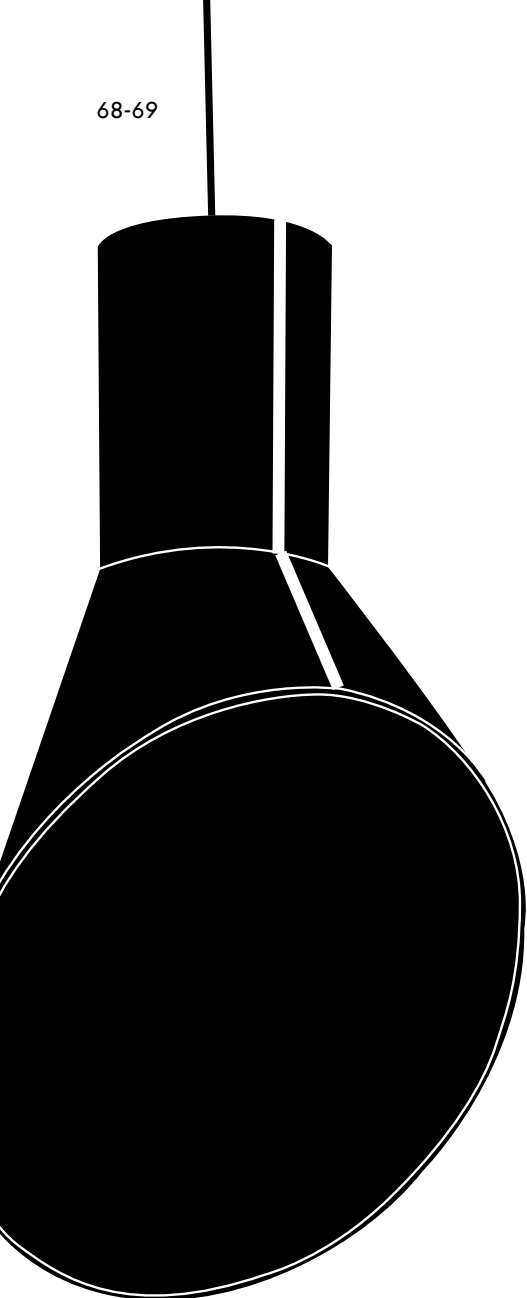

# Cargo

Hervé Langlais



Faisant écho aux légendaires cheminées de paquebot, la collection **Cargo** se distingue par la pureté de ses formes. Fabriquée en France, sa réalisation constitue un exercice exigeant dans le travail de l'abat-jour. Elle est déclinée en plusieurs tailles et modèles, qui peuvent être assemblés en grappe."

" Echoing the legendary design of steam liner funnels, the **Cargo** collection is characterized by the purity of its form. Made in France, its manufacturing creating the lampshade is a demanding and precise exercise. Cargo is available in several sizes and designs, which can be clustered together. "

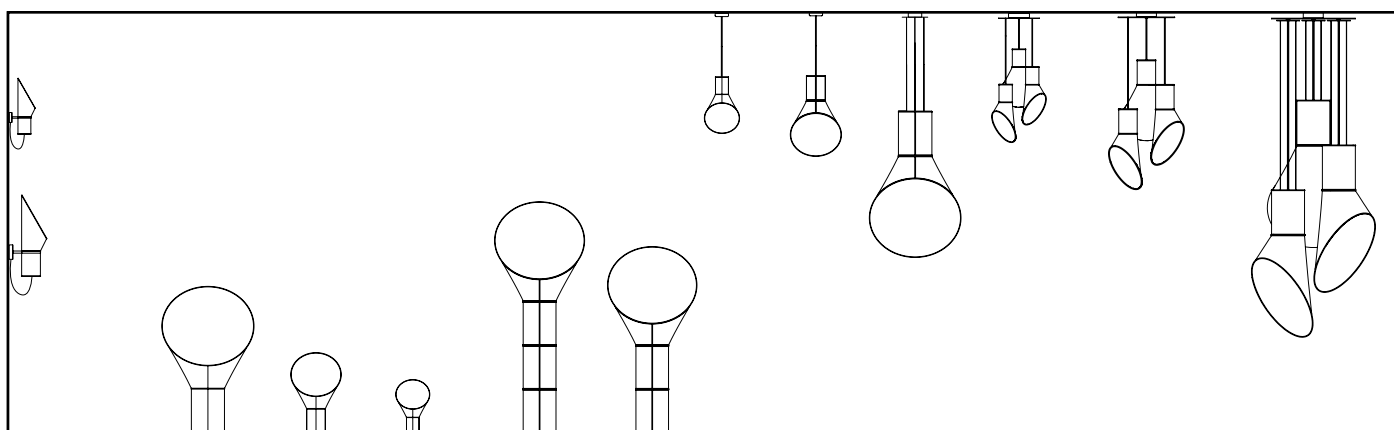





Hôtel EKTA - Paris - France. Photo Christophe Bielsa ©

# Collection Cargo

Design : Hervé Langlais

# Cargo

Hervé Langlais

## Lampe 1 Grand Cargo















## Lampe 2 Petit Cargo

## Lampe 3 Baby Cargo



Existe en trois tailles et deux coloris."

" Available in three sizes and two colors."

<b>1</b> Lampe Grand Cargo Large Ref : L117gc	L. 72 x l. 37 x H. 117 cm - Fil textile/Textile cord 2 m/6.6' Max 100 W - 230 V : E27 - 120 V : E26 - Non fournie/Not incl.	     850° V
<b>2</b> Lampe Petit Cargo Small Ref : L67pc	L. 40 x l. 23 x H. 67 cm - Fil textile/Textile cord 2 m/6.6' Max 60 W - 230 V : E27 - 120 V : E26 - Non fournie/Not incl.	     850° V
<b>3</b> Lampe Baby Cargo Baby Ref : L47bc	L. 27 x l. 14 x H. 47 cm - Fil textile/Textile cord 2 m/6.6' Max 40 W - 230 V : E14 - 120 V : E12 - Non fournie/Not incl.	     850° V
Finitions/ Finishes	Voir page 143-149/See page 143-149	
Matériaux Materials	Tissus ou pvc laqué, acier laqué, fil tissé coloré. Fabric or lacquered pvc, lacquered steel, colored textile cord.	

MADE IN  
FRANCE

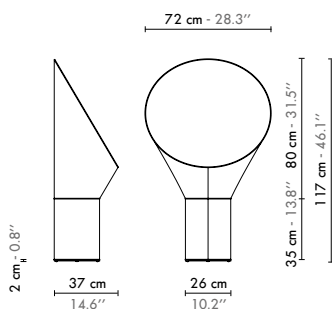

**1** Ref : L117gc

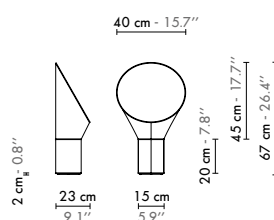

**2** Ref : L67pc

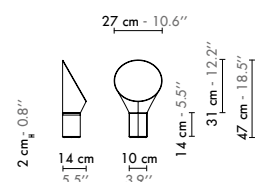

**3** Ref : L47bc







# Cargo

Hervé Langlais

## Lampadaire ■ Grand Cargo 3













## Lampadaire ■ Grand Cargo 2



Telle une cheminée de Cargo, la hauteur du lampadaire peut être augmentée par ajout de 1 ou 2 cylindres. Des modèles de différentes hauteurs peuvent être groupés."

" The height of the lamp can be increased by extending the number of cylinders in the 'funnel' by one or two.

Models of different heights can also be grouped together. "

<b>1</b> Lampadaire Grand Cargo 3 Large Ref : L187gc	L. 72 x l. 37 x H. 187 cm - 3 cylindres/3 cylinders - Fil textile/Textile cord 2 m/6.6' - Max 100 W - 230 V : E27 - 120 V : E26 - Non fournie/Not incl.	     850 
<b>2</b> Lampadaire Grand Cargo 2 Large Ref : L152gc	L. 72 x l. 37 x H. 152 cm - 2 cylindres/2 cylinders - Fil textile/Textile cord 2 m/6.6' - Max 100 W - 230 V : E27 - 120 V : E26 - Non fournie/Not incl.	     850 
Finitions/ Finishes	Voir page 143-149/See page 143-149	
Matériaux Materials	Tissus ou pvc laqué, acier laqué, fil tissé coloré. Fabric or lacquered pvc, lacquered steel, colored textile cord.	

MADE IN  
FRANCE

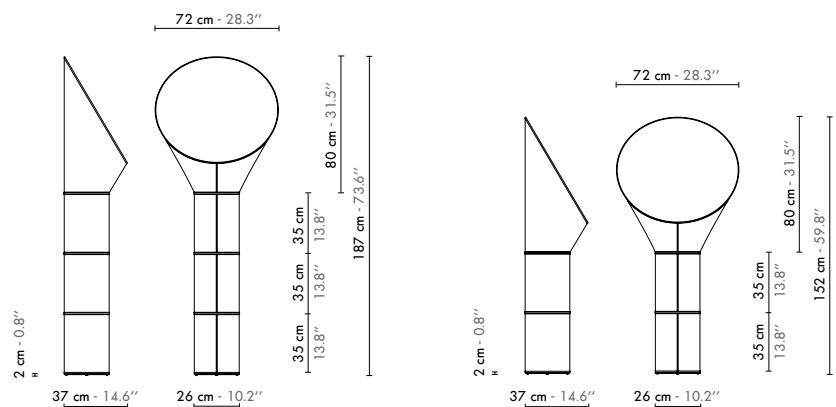

**1** Ref : L187gc

**2** Ref : L152gc



2

1

# Cargo

Hervé Langlais











## Applique 1 Petit Cargo

## Applique 2 Baby Cargo



Les appliques, disponibles en deux tailles, peuvent être tournées de face ou de dos, tête en bas ou inversement."

"The wall lights are available in two sizes. They can be rotated back to front, or even upside down."

<b>1</b> Applique Petit Cargo Small Ref : A65pc	L. 40 x l. 31 x H. 65 cm - Fil textile/Textile cord 0,5 m/1.6' Max 60 W - 230 V : E27 - 120 V : E26 - Non fournie/Not incl.	     850°
<b>2</b> Applique Baby Cargo Baby Ref : A45bc	L. 27 x l. 22 x H. 45 cm - Fil textile/Textile cord 0,4 m/1.3' Max 40 W - 230 V : E14 - 120 V : E12 - Non fournie/Not incl.	     850°
Finitions/ Finishes	Voir page 143-149/See page 143-149	
Matériaux Materials	Tissus ou pvc laqué, acier laqué, fil tissé coloré. Fabric or lacquered pvc, lacquered steel, colored textile cord.	

MADE IN  
FRANCE

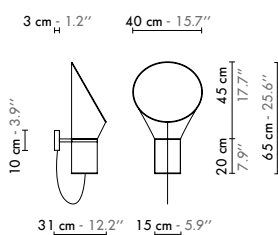

**1** Ref : A65pc

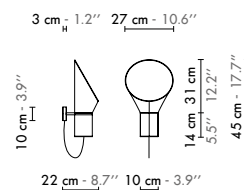

**2** Ref : A45bc





2



1

# Cargo

Hervé Langlais



Déclinées en plusieurs tailles et coloris, les suspensions peuvent être assemblées en grappe."

"The suspended lamps are available in several sizes and colors that can be assembled together like a cluster."

## Suspension ■ Grand Cargo

## Suspension ■ Petit Cargo

## Suspension ■ Baby Cargo

- |   |  |
|---|--|
| <b>1</b> Suspension<br>Grand Cargo<br>Large<br>Ref : S115gc | <b>Hauteur sous plafond min 3,5 m/Ceiling height min 12'</b><br>L. 72 x l. 37 x H. 115 cm - Fil textile/Textile cord 2 m/6.6' - Câbles acier/<br>Steel cables 3 x 2 m/3 x 6.6' - Max 60 W - 230 V : E27 - 120 V : E26 -<br>Non fournie/Not incl. |
| <b>2</b> Suspension<br>Petit Cargo<br>Small<br>Ref : S65pc  | <b>Hauteur sous plafond min 2,8 m/Ceiling height min 9'</b><br>L. 40 x l. 23 x H. 65 cm - Fil textile/Textile cord 2 m/6.6'<br>Max 60 W - 230 V : E27 - 120 V : E26 - Non fournie/Not incl.  |
| <b>3</b> Suspension<br>Baby Cargo<br>Baby<br>Ref : S45bc    | <b>Hauteur sous plafond min 2,5 m/Ceiling height min 8'</b><br>L. 27 x l. 14 x H. 45 cm - Fil textile/Textile cord 2 m/6.6'<br>Max 40 W - 230 V : E14 - 120 V : E12 - Non fournie/Not incl.  |



Finitions/  
Finishes Voir page 143-149/See page 143-149

Matériaux  
Materials Tissus ou pvc laqué, acier laqué, fil tissé coloré.  
Fabric or lacquered pvc, lacquered steel, colored textile cord.

MADE IN  
FRANCE

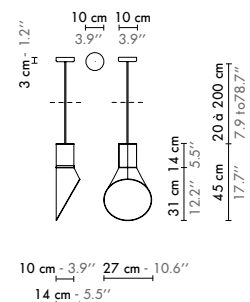
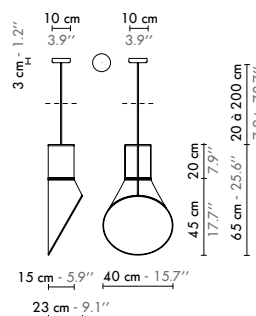
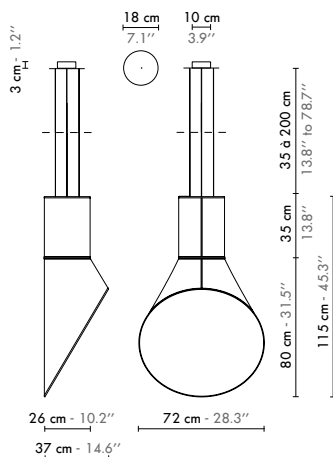

1 Ref : S115gc



2 Ref : S65pc



3 Ref : S45bc





# Cargo

Hervé Langlais



Tels une sculpture lumineuse, les baby, petits ou grands modèles de lustres, à choisir en fonction des hauteurs de plafond, sublimeront votre espace par leur élégance et leur pureté."

"Baby, small or large models of chandeliers can be selected according to ceiling height. Regardless of size, Cargo will enhance your space with their clean elegance similar to a luminous sculpture."

## Lustre 3 ■ Grand Cargo

## Lustre 3 ■ Petit Cargo

## Lustre 3 ■ Baby Cargo

<b>1</b> Lustre 3 Grand Cargo Large Ref : Lu3gc	<b>Hauteur sous plafond min 4 m / Ceiling height min 13'</b> Abj/Ls : L. 72 x l. 37 x H. 115 cm - Fil textile/Textile cord 3 x 2 m/3 x 6.6' - Câbles acier/ Steel cables 9 x 2 m/9 x 6.6' 3 x Max 60 W - 230 V : E27 - 120 V : E26 - Non fournie/Not incl.     
<b>2</b> Lustre 3 Petit Cargo Small Ref : Lu3pc	<b>Hauteur sous plafond min 3 m / Ceiling height min 10'</b> Abj/Ls : L. 40 x l. 23 x H. 65 cm - Fil textile/Textile cord 3 x 2 m/3 x 6.6' 3 x Max 60 W - 230 V : E27 - 120 V : E26 - Non fournie/Not incl.     
<b>3</b> Lustre 3 Baby Cargo Baby Ref : Lu3bc	<b>Hauteur sous plafond min 2,5 m / Ceiling height min 9'</b> Abj/Ls : L. 27 x l. 14 x H. 45 cm - Fil textile/Textile cord 3 x 1 m/3 x 3.3' 3 x Max 40 W - 230 V : E14 - 120 V : E12 - Non fournie/Not incl.     
<b>Finitions/ Finishes</b> Voir page 143-149/See page 143-149	
<b>Matériaux/ Materials</b> Tissus ou pvc laqué, acier laqué, fil tissé coloré. Fabric or lacquered pvc, lacquered steel, colored textile cord.	

MADE IN FRANCE

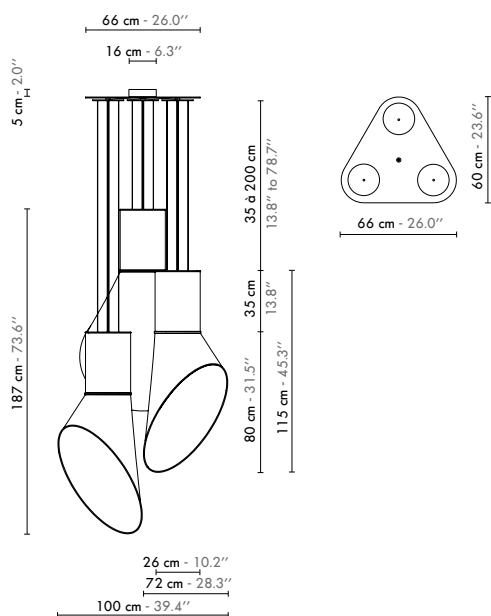

**1** Ref : Lu3gc

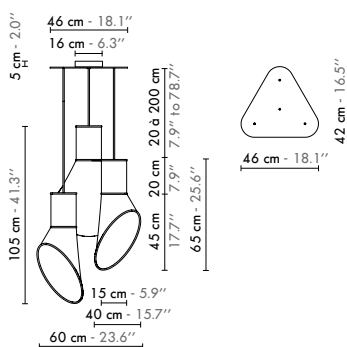

**2** Ref : Lu3pc

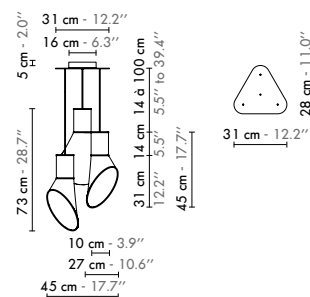

**3** Ref : Lu3bc



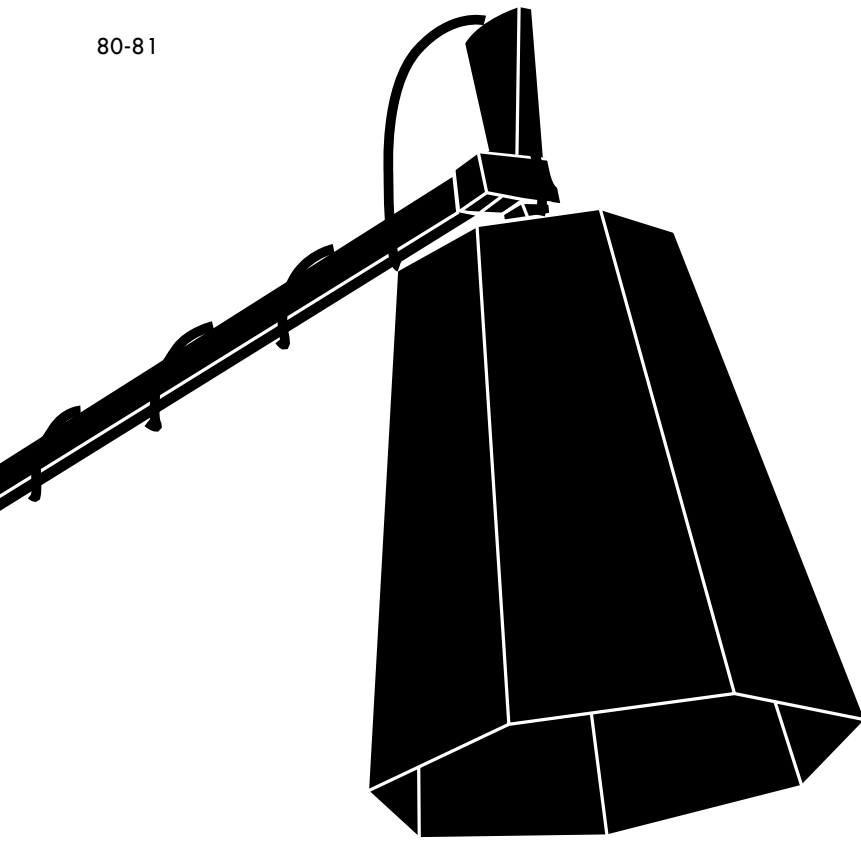

# LuXiole

Kristian Gavaille



**LuXiole** est une collection naturelle, simple et corsée tout à la fois, qui s'adresse à ceux qui souhaitent voir la vie en grand, en toute simplicité. Elle semble prendre vie et devenir animale. L'abat-jour est inspiré des formes à facettes de la cafetière italienne mais renversée telle une clochette, pour redonner au corsé toute sa légèreté. Fabriquée en France avec des finitions de très belle qualité, en hêtre, fonte d'aluminium, fils et abat-jour textiles colorés."

" **LuXiole** is a collection for those who want to see life's big picture. It is a natural, simple and powerful collection that recalls the vibrancy of wildlife. The shade is inspired by the familiar angles of an Italian coffee maker, but turned on its head, dispelling more industrial associations. Made in France, LuXiole is composed of cast aluminium, finished in beech, with colorful textile cords and shades."

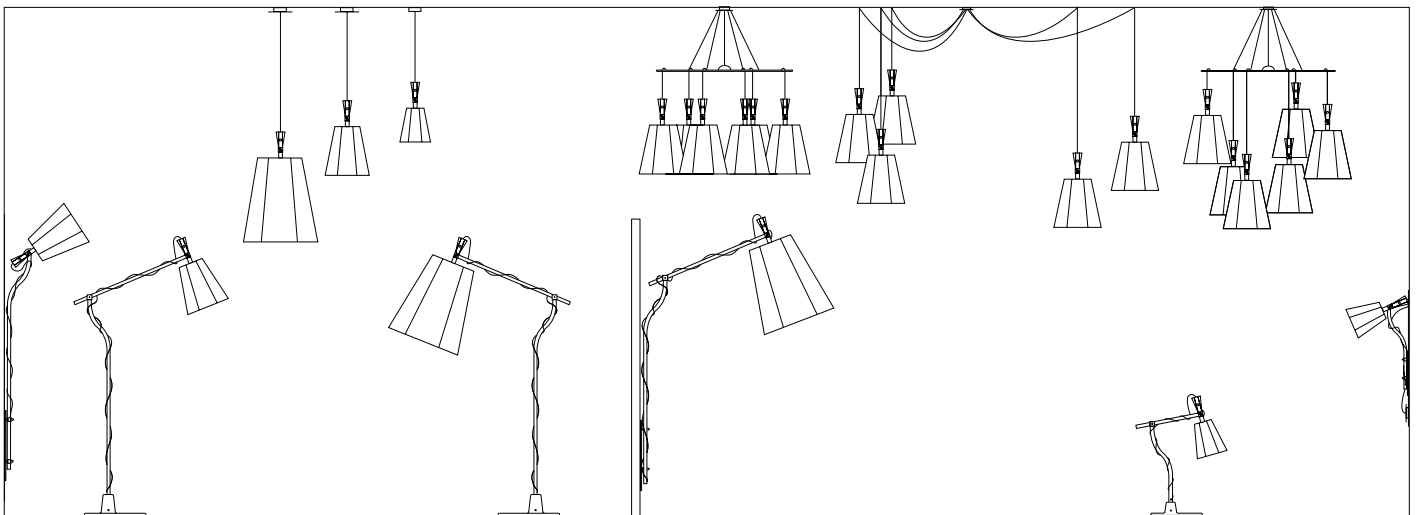

Versions disponibles / Available models





# Collection LuXiole

Design : Kristian Gavaille



# LuXiole

Kristian Gavaille



## Lampadaire ■ Grand LuXiole

## Lampe à poser ■ Petit LuXiole



Telles des lampes d'architectes, l'amplitude de leur articulation combinée avec une hauteur exceptionnelle permettent un éclairage central et chaleureux."

" Similar to architects' lamps, the breadth of articulation combined with exceptional height provides a warm and central lighting source."

- 1 Lampadaire Grand LuXiole Large Ref : L2251 L. 136 x l. 45 x H. 225 cm - Mini : L. 90 x l. 45 x H. 200 cm - Maxi : L. 156 x l. 45 x H. 315 cm - Abj/Ls : L. 40 x l. 40 x H. 42 cm - Fil textile/Textile cord 2 m/6.6' - 1 x Max 60 W - 230 V : E27 - 120 V : E26 - Non fournie/Not incl.



- 2 Lampe Petit LuXiole Small Ref : L981 L. 67 x l. 25 x H. 98 cm - Abj/Ls : L. 25 x l. 25 x H. 27 cm - Fil textile/Textile cord 2 m/6.6' - 1 x Max 40 W - 230 V : E27 - 120 V : E26 - Non fournie/Not incl.



Finitions/  
Finishes

Voir page 143-149/See page 143-149

Matériaux  
Materials

Tissus, hêtre massif, bois de hêtre lamellé-collé, fonte d'aluminium, aluminium laqué, fil tissé coloré/Fabric, laminated beech wood, solid beech, cast aluminium and lacquered, colored textile cord.

MADE IN  
FRANCE

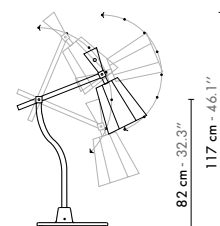
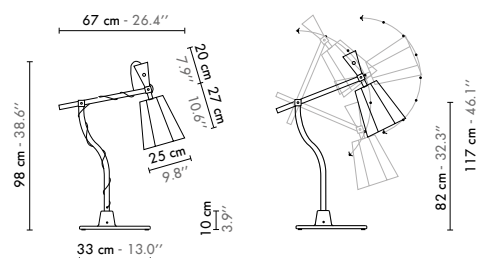
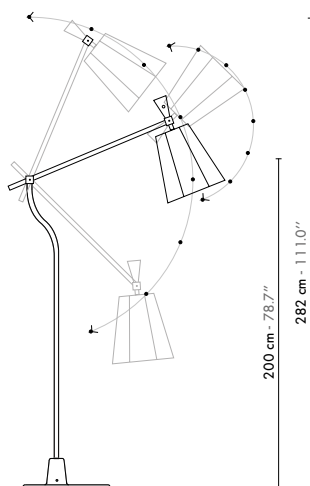
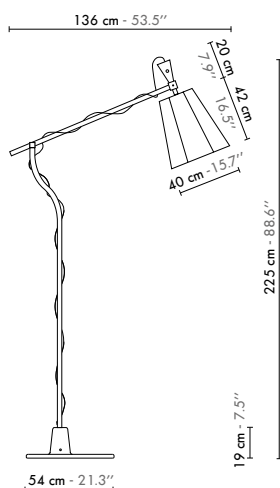

1 Ref : L2251

8 Positions bras et abat-jour  
8 Arm and lampshade positions

2 Ref : L981

7 Positions bras et abat-jour  
7 Arm and lampshade positions





1

2



# LuXiole

Kristian Gavaille



//

Telles des lampes d'architectes, l'amplitude de leur articulation combinée avec une hauteur exceptionnelle permettent un éclairage central et chaleureux."

"Such as architects lamps, the breadth of articulation combined with exceptional height gives a warm and central lighting source."

## Lampadaire mural ■ XXL LuXiole

## Lampadaire ■ XXL LuXiole

<p>1 Lampadaire mural XXL LuXiole Wall floorlamp Ref : Lm253xxll</p>	<p>L. 163 x l. 66 x H. 253 cm - Abj/Ls : L. 66 x l. 66 x H. 72 cm - Fil textile/ Textile cord 2 m/6.6' - 1 x Max 65 W - 230 V : E27 - 120 V : E26 - Non fournie/Not incl.</p>	
<p>2 Lampadaire XXL LuXiole Floorlamp Ref : L255xxll</p>	<p>L. 157 x l. 66 x H. 255 cm - Abj/Ls : L. 66 x l. 66 x H. 72 cm - Fil textile/ Textile cord 2 m/6.6' - 1 x Max 65 W - 230 V : E27 - 120 V : E26 - Non fournie/Not incl.</p>	
<p>Finitions/ Finishess</p> <p>Voir page 143-149/See page 143-149</p>		
<p>Matériaux Materials</p> <p>Tissus, hêtre massif, bois de hêtre lamellé-collé, fonte d'aluminium, alu- minium laqué, fil tissé coloré/Fabric, laminated beech wood, solid beech, cast aluminium and lacquered, colored textile cord.</p>		

MADE IN  
FRANCE

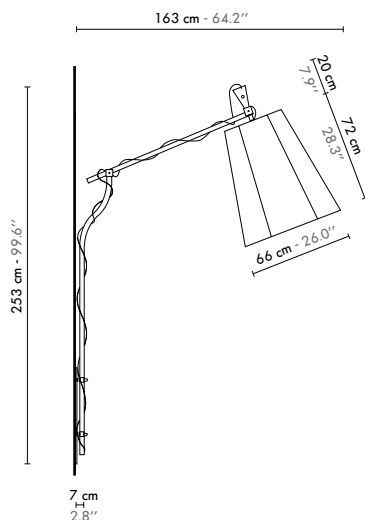

1 Ref : Lm253xxll

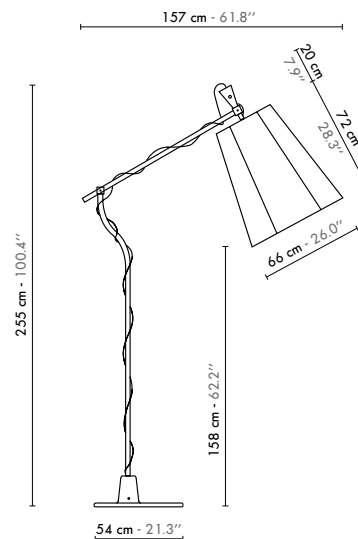

2 Ref : L255xxll

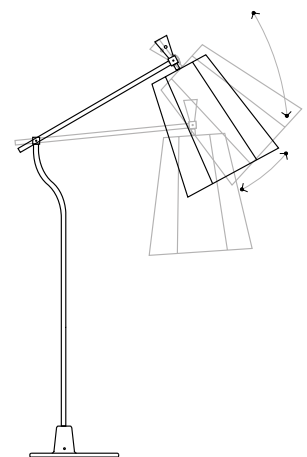

2 Positions bras et abat-jour  
2 Arm and lampshade positions



# LuXiolo

Kristian Gavaille



## Lampadaire mural ■ Grand LuXiolo

## Applique ■ Grand LuXiolo



Ingénieux, ce lampadaire articulé fixé au mur et cette grande applique murale sont branchés sur une simple prise. Le lampadaire mural permet un éclairage central sans entraver la circulation grâce à sa taille hors norme."

" Ingeniously, the wall configuration is simply connected to a wall socket. The long, jointed arm provides a flexible central lighting source without obstructing the passage--impressive considering its extraordinary size."

<b>1</b> Lampadaire mural Grand LuXiolo Large Ref : Lm223l	L. 140 x l. 40 x H. 223 cm - Mini : L. 70 x l. 40 x H. 199 cm - Maxi : L. 165 x l. 40 x H. 313 cm - Abj/Ls : L. 40 x l. 40 x H. 42 cm - Fil textile/ Textile cord 2 m/6.6' - 1 x Max 60 W - 230 V : E27 - 120 V : E26 - Non fournie/Not incl.
---	--



<b>2</b> Applique Grand LuXiolo Large Ref : Gam219l	L. 55 x l. 40 x H. 219 cm - Mini : L. 45 x l. 40 x H. 195 cm - Maxi : L. 75 x l. 40 x H. 225 cm - Abj/Ls : L. 40 x l. 40 x H. 42 cm - Fil textile/Textile cord 2 m/6.6' - 1 x Max 60 W - 230 V : E27 - 120 V : E26 - Non fournie/Not incl.
--	--



Finitions/  
Finishes

Voir page 143-149/See page 143-149

Matériaux  
Materials

Tissus, hêtre massif, bois de hêtre lamellé-collé, fonte d'aluminium, acier laqué, fil tissé coloré/Fabric, laminated beech wood, solid beech, cast aluminium and lacquered steel, colored textile cord.

MADE IN FRANCE

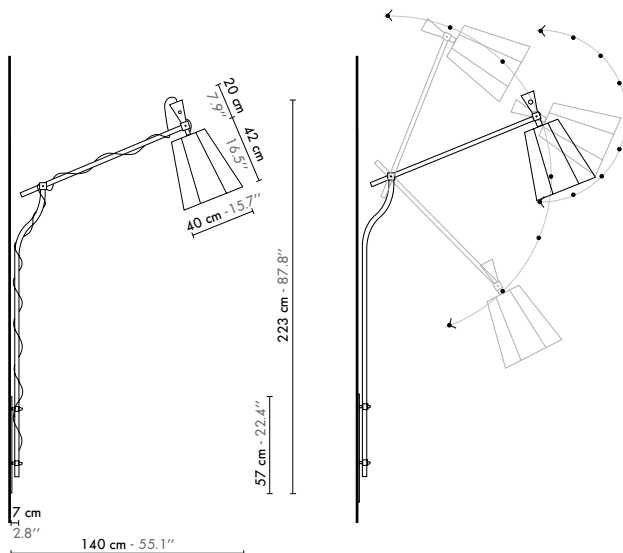

**1** Ref : Lm223l

8 Positions bras et abat-jour  
8 Arm and lampshade positions

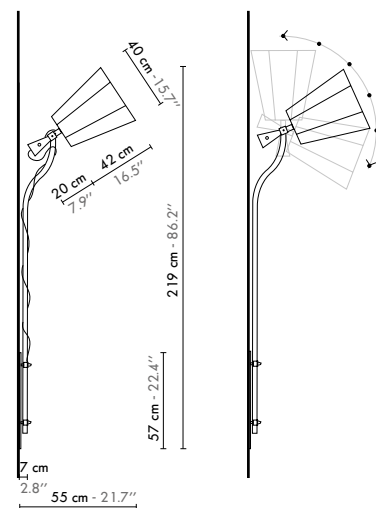

**2** Ref : Gam219l

6 Positions abat-jour  
6 Lampshade positions





# LuXiole

Kristian Gavaille

## Applique ■ Petit LuXiole

//

Cette applique de belle dimension permet un déport réglable entre l'alimentation et la lampe même."

" The beautifully proportioned smaller version of the wall light allows for greater distance from wall outlets. "

■ Applique  
Petit LuXiole  
Small  
Ref : Pam90l

L. 51 x l. 25 x H. 90 cm - Maxi : L. 51 x l. 25 x H. 110 cm - Abj/Ls : L. 25 x l. 25 x H. 27 cm - Fil textile/Textile cord 1 m/3.3' - 1 x Max 40 W - 230 V : E27 - 120 V : E26 - Non fournie/Not incl.



Finitions/  
Finishes

Voir page 143-149/See page 143-149

Matériaux  
Materials

Tissus, hêtre massif, bois de hêtre lamellé-collé, fonte d'aluminium, acier laqué, fil tissé coloré/Fabric, laminated beech wood, solid beech, cast aluminium and lacquered steel, colored textile cord.

MADE IN  
FRANCE

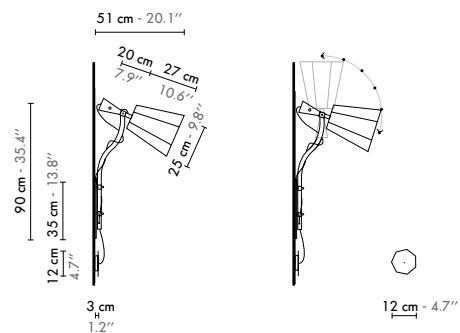

■ Ref : Pam90l

6 Positions abat-jour  
6 Lampshade positions





# LuXiole

Kristian Gavaille

## Suspension 1 XXL LuXiole





















## Suspension 2 Grand LuXiole

## Suspension Petit LuXiole 3 avec poignée bois massif

## Suspension Petit LuXiole 4 sans poignée bois massif

“ Ses formes octogonales focalisent la lumière et marquent l’espace d’une empreinte corsée et chaleureuse.”

“ Its octagonal form focus light and mark spaces with a strong imprint and warmth.”

<b>1</b> Suspension XXL LuXiole XXL Ref : Sxxll	Abj/Ls : L. 66 x l. 66 x H. 72 cm - Fil textile/Textile cord 3 m/9.8' - 1 x Max 65 W - 230 V : E27 - 120 V : E26 - Non fournie/Not incl.     
<b>2</b> Suspension Grand LuXiole Large Ref : Sgl	Abj/Ls : L. 40 x l. 40 x H. 42 cm - Fil textile/Textile cord 2 m/6.6' - 1 x Max 60 W - 230 V : E27 - 120 V : E26 - Non fournie/Not incl.     
<b>3</b> Suspension Petit LuXiole avec poignée Small Ref : Splap	Abj/Ls : L. 25 x l. 25 x H. 27 cm - Fil textile/Textile cord 2 m/6.6' - 1 x Max 40 W - 230 V : E27 - 120 V : E26 - Non fournie/Not incl.     
<b>4</b> Suspension Petit LuXiole sans poignée Small Ref : Splsp	Abj/Ls : L. 25 x l. 25 x H. 27 cm - Fil textile/Textile cord 2 m/6.6' - 1 x Max 40 W - 230 V : E27 - 120 V : E26 - Non fournie/Not incl.     
Finitions/ Finishes	Voir page 143-149/See page 143-149
Matériaux Materials	Tissus, hêtre massif, fonte d'aluminium, acier laqué, fil tissé coloré/Fabric, solid beech, steel lacquered, colored textile cord.

MADE IN FRANCE

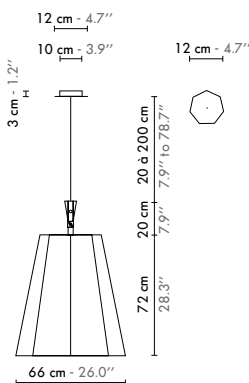

1 Ref : Sxxll

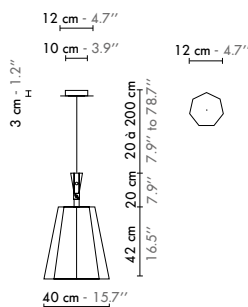

2 Ref : Sgl

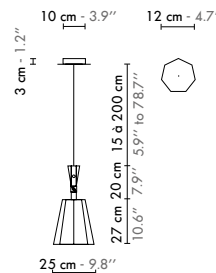

3 Ref : Splap

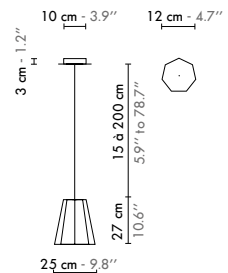

4 Ref : Spl



# LuXiole

Kristian Gavaille

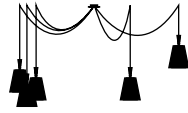

## Lustre 5 **1** XXL LuXiole

## Lustre 5 **2** Grand LuXiole

## Lustre 5 **3** Petit LuXiole



Ces lustres sont disponibles en version Nid d'abeilles ou asymétrique. Leur design octogonal associé au bois de hêtre, marqueront l'espace d'une empreinte corsée et chaleureuse."

" These chandeliers are available in the honeycomb or asymmetrical shape. Their octagonal design combined with the beech wood base marks the space with a strong imprint and warmth."

- |  |  |
|--|--|
| <p><b>1</b> Lustre 5<br/>XXL LuXiole<br/>XXL<br/>Ref : Lu5xxll</p>     | <p>Hauteur sous plafond min 3,7 m/Ceiling height min 12'<br/>L. 460 x l. 460 x H. 270 cm - Abj/Ls : L. 66 x l. 66 x H. 72 cm<br/>Fil textile/Textile cord 4 m/13.1'<br/>5 x Max 60 W - 230 V : E27 - 120 V : E26 - Non fournie/Not incl.</p> |
| <p><b>2</b> Lustre 5<br/>Grand LuXiole<br/>Large<br/>Ref : Lu5gl</p>   | <p>Hauteur sous plafond min 3,2 m/Ceiling height min 10'<br/>L. 320 x l. 320 x H. 200 cm - Abj/Ls : L. 40 x l. 40 x H. 42 cm<br/>Fil textile/Textile cord 3 m/9.8'<br/>5 x Max 60 W - 230 V : E27 - 120 V : E26 - Non fournie/Not incl.</p>  |
| <p><b>3</b> Lustre 5<br/>Petit LuXiole<br/>Small<br/>Ref : Lu5plap</p> | <p>Hauteur sous plafond min 2,7 m/Ceiling height min 9'<br/>L. 220 x l. 220 x H. 135 cm - Abj/Ls : L. 25 x l. 25 x H. 27 cm<br/>Fil textile/Textile cord 2 m/6.6'<br/>5 x Max 40 W - 230 V : E27 - 120 V : E26 - Non fournie/Not incl.</p>   |



Finitions/ Finishes Voir page 143-149/See page 143-149

Matériaux Materials Tissus, hêtre massif, fonte d'aluminium, acier laqué, fil tissé coloré/Fabric, solid beech, steel lacquered, colored textile cord.

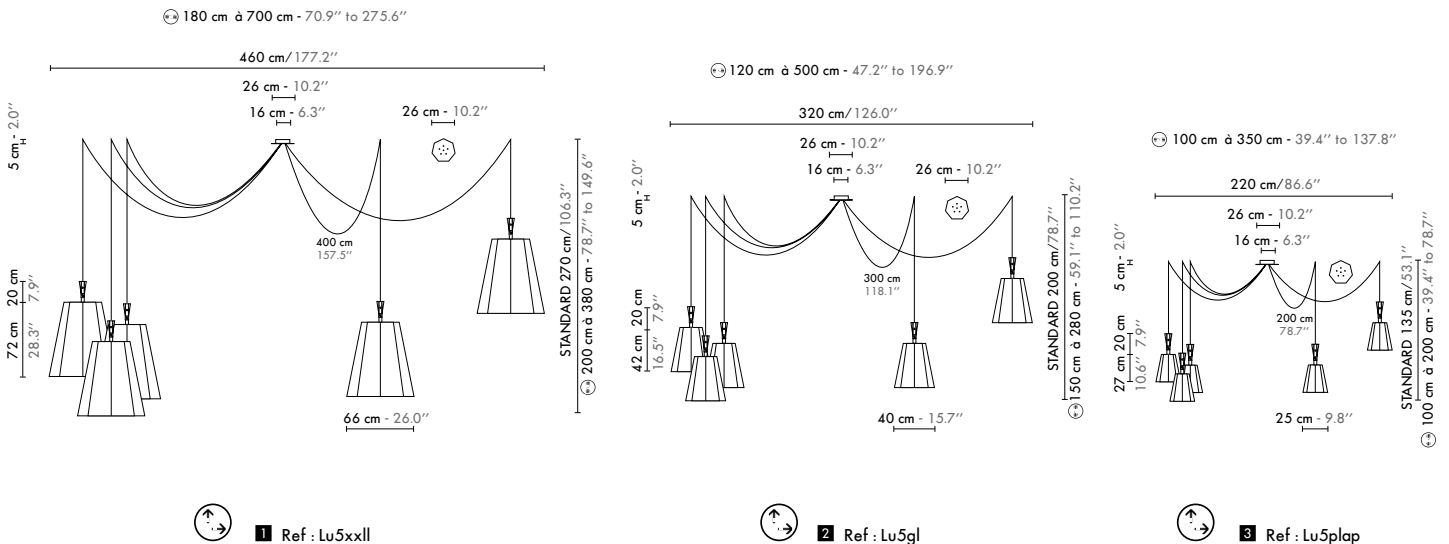





# LuXiolo

Kristian Gavaille



Ces lustres sont disponibles en version Nid d'abeilles ou asymétrique. Leur design octogonal associé au bois de hêtre, marqueront l'espace d'une empreinte corsée et chaleureuse."

" These chandeliers are available in the honeycomb or asymmetrical shape. Their octagonal design combined with the beech wood base marks the space with a strong imprint and warmth."

## Lustre 6 ■ Nid d'Abeilles LuXiolo

## Lustre 6 ■ Asymétrique LuXiolo

- 1 Lustre 6  
Nid d'abeilles  
Large  
Ref : Luólna

Hauteur sous plafond min 3,6 m/Ceiling height min 12'  
L. 145 x l. 106 x H. min 135 cm - Abj/Ls : L. 40 x l. 40 x H. 42 cm  
Fil textile/Textile cord 2 m/6.6'  
6 x Max 60 W - 230 V : E27 - 120 V : E26 - Non fournie/Not incl.



- 2 Lustre 6  
Asymétrique  
Large  
Ref : Luólas

Hauteur sous plafond min 4,5 m/Ceiling height min 15'  
L. 145 x l. 106 x H. min 225 cm - Abj/Ls : L. 40 x l. 40 x H. 42 cm  
Fil textile/Textile cord 2 m/6.6'  
6 x Max 60 W - 230 V : E27 - 120 V : E26 - Non fournie/Not incl.



Finitions/  
Finishes Voir page 143-149/See page 143-149

Matériaux  
Materials Tissus, hêtre massif, bois de hêtre lamellé-collé, fonte d'aluminium, acier laqué, fil tissé coloré/Fabric, laminated beech wood, solid beech, cast steel and lacquered, colored textile cord.

MADE IN FRANCE

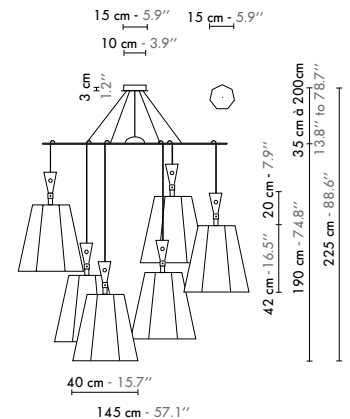
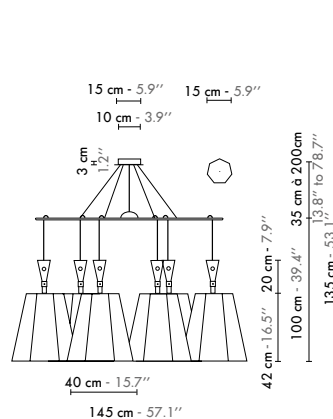

1 Ref : Luólna



2 Ref : Luólas







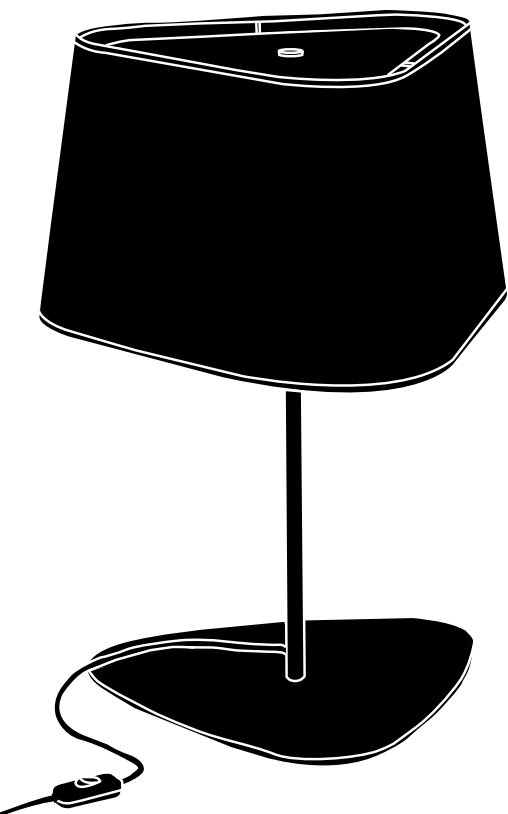

# Nuage

Hervé Langlais



La collection **Nuage** est un concept élégant et ingénieux d'éclairage nomade. Sa légèreté et son adaptabilité en font le best-seller des collections Designheure. Simplicité et pureté des lignes de cette collection intemporelle et universelle. L'abat-jour de forme triangulaire produit une lumière bien particulière, découpant l'espace de façon architecturale. Sa ligne élégante apparentée à la proue d'un bateau est rehaussée par le cordon textile. L'offre sur mesure de cette collection permet de créer des projets uniques."

" **Nuage** is a stylishly designed and cleverly made lighting system. Its lightness and adaptability has made it Designheure's bestselling collection. Chosen for its simplicity and pure lines, this timeless collection takes its inspiration from the prow of a ship. The triangular shade produces a unique light, cutting through space as a boat does through the sea. Elegant lines, enhanced by the textile cord, make Nuage a favorite in both residential and commercial spaces. Its ability to be customized enable to create very unique projects."

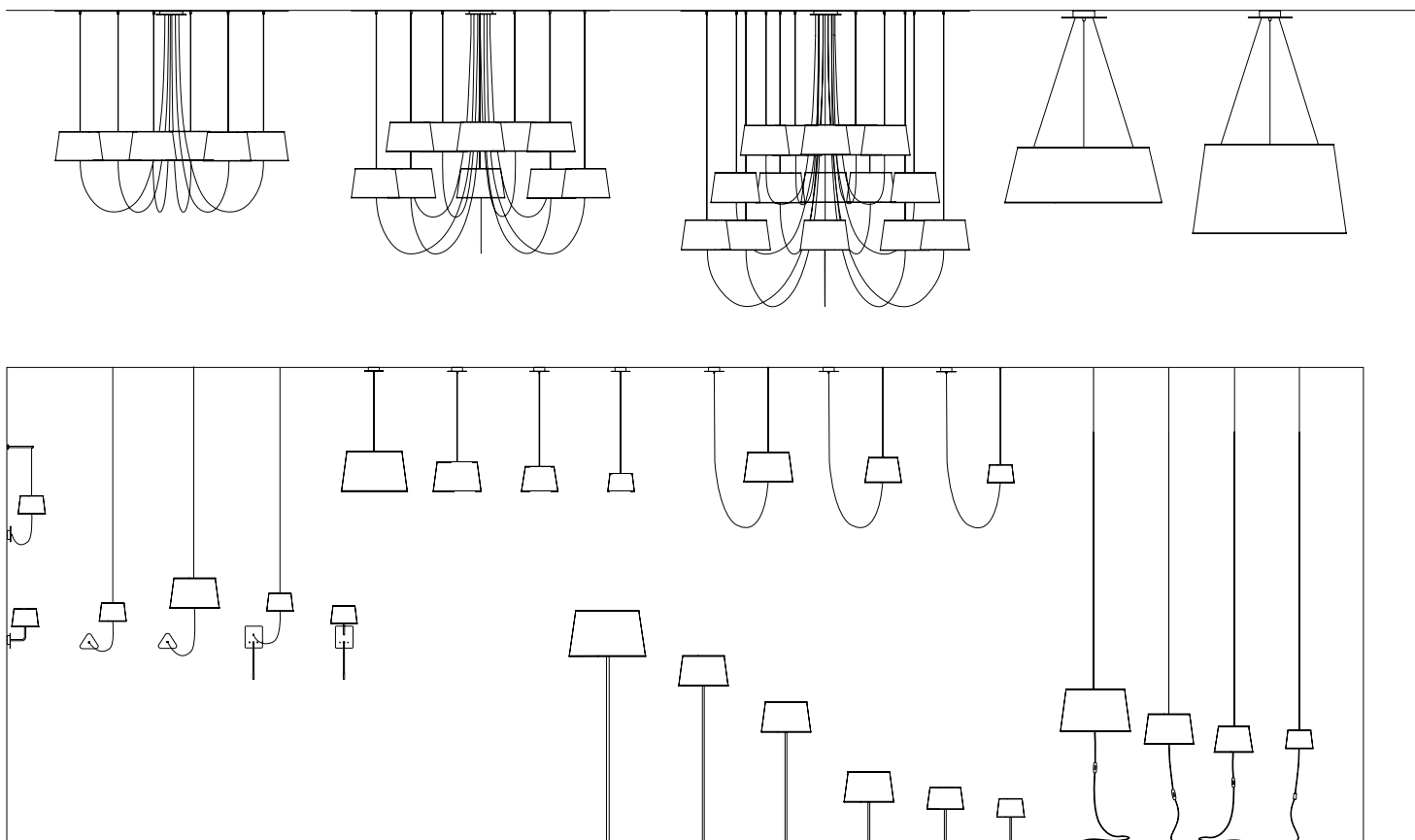



Restaurant Le Riche, Alès - France.  
Arch. C. Urtis, Photo Jonathan Vaele.fr ©

# Collection Nuage

Design : Hervé Langlais

# Nuage



Hervé Langlais

## Lampe à poser 1 Grand Nuage















## Lampe à poser 2 Moyen Nuage

## Lampe à poser 3 Petit Nuage



Existe en trois tailles et huit coloris."

" Available in three sizes and eight colors."

<b>1</b> Lampe Grand Nuage Large Ref : L62gn	L. 43 x l. 43 x H. 62 cm - Abj/Ls : L. 43 x l. 43 x H. 26 cm - Fil textile/ Textile cord 2 m/6.6' - 1 x Max 100 W - 230 V : E27 - 120 V : E26 - H. max 130 mm/bulb MOL 5.1" - Non fournie/Not incl.      850° V
<b>2</b> Lampe Moyen Nuage Medium Ref : L49mn	L. 32 x l. 32 x H. 49 cm - Abj/Ls : L. 32 x l. 32 x H. 19 cm - Fil textile/ Textile cord 2 m/6.6' - 1 x Max 60 W - 230 V : E27 - 120 V : E26 - H. max 115 mm/bulb MOL 4.5" - Non fournie/Not incl.      850° V
<b>3</b> Lampe Petit Nuage Small Ref : L39pn	L. 24 x l. 24 x H. 39 cm - Abj/Ls : L. 24 x l. 24 x H. 16 cm - Fil textile/ Textile cord 2 m/6.6' - 1 x Max 40 W - 230 V : E14 - 120 V : E12 - H. max 90 mm/bulb MOL 3.5" - Non fournie/Not incl.      850° V
Finitions/ Finishes	Voir page 143-149/See page 143-149
Matériaux Materials	Tissus ou laqué, acier laqué, fil tissé coloré. Fabric or lacquered, lacquered steel, colored textile cord.

MADE IN  
FRANCE

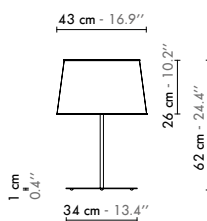

**1** Ref : L62gn

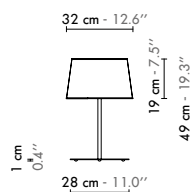

**2** Ref : L49mn

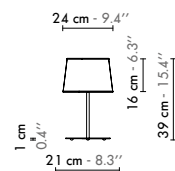

**3** Ref : L39pn





3

2

# Nuage

Hervé Langlais



## Lampadaire 1 182 XL Nuage

## Lampadaire 2 162 Grand Nuage

## Lampadaire 3 122 Grand Nuage



Existe en trois tailles et neuf coloris."

" Available in three sizes and nine colors."

<b>1</b> Lampadaire 182 XL Nuage Ref : L182xln	L. 60 x l. 60 x H. 182 cm - Abj/Ls : L. 60 x l. 60 x H. 35 cm - Fil textile/ Textile cord 2 m/6.6' - 1 x Max 100 W - 230 V : E27 - 120 V : E26 - H. max 130 mm/bulb MOL 5.1" - Non fournie/Not incl.	850°
<b>2</b> Lampadaire 162 Grand Nuage Large Ref : L162gn	L. 43 x l. 43 x H. 162 cm - Abj/Ls : L. 43 x l. 43 x H. 26 cm - Fil textile/ Textile cord 2 m/6.6' - 1 x Max 100 W - 230 V : E27 - 120 V : E26 - H. max 130 mm/bulb MOL 5.1" - Non fournie/Not incl.	850°
<b>2</b> Lampadaire 122 Grand Nuage Large Ref : L122gn	L. 43 x l. 43 x H. 122 cm - Abj/Ls : L. 43 x l. 43 x H. 26 cm - Fil textile/ Textile cord 2 m/6.6' - 1 x Max 100 W - 230 V : E27 - 120 V : E26 - H. max 130 mm/bulb MOL 5.1" - Non fournie/Not incl.	850°
Finitions/ Finishes	Voir page 143-149/See page 143-149	
Matériaux Materials	Tissus ou laqué, acier laqué, fil tissé coloré. Fabric or lacquered, lacquered steel, colored textile cord.	

MADE IN  
FRANCE

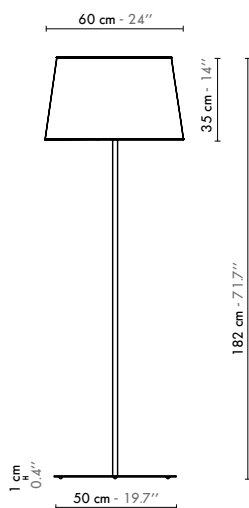

**1** Ref : L182xln

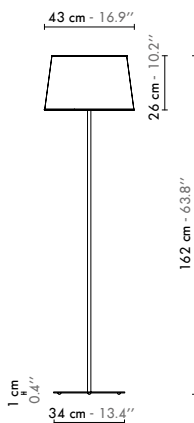

**2** Ref : L162gn

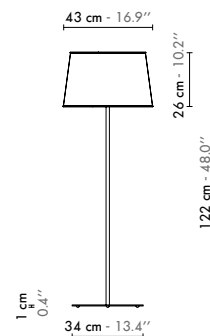

**3** Ref : L122gn





2

3



# Nuage

Hervé Langlais

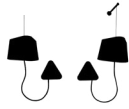

Dans l'esprit nomade, cette applique offre une grande liberté de placement de la lampe. Son fil textile permet de déporter la source lumineuse par rapport à l'arrivée électrique, et de faire varier la hauteur grâce au coulissement de l'abat-jour sur le câble inox. Disponible en trois tailles, petit moyen et grand, et en deux systèmes de fixation, murale et suspendue pour la petite taille uniquement."

In the nomadic spirit, this wall light can find a home in any space thanks to a textile cord that gives more flexibility to be away from power supplies. The sliding lampshade on the steel cable is also an ingenious way to adjust height.

Available in three sizes, small, medium and large, and with two fixing systems, wall mounted, or (only for the small size), in suspended version."

























## Applique suspendue 1 Grand Nuage

## Applique suspendue 2 Moyen Nuage

## Applique suspendue 3 Petit Nuage

## Applique tige murale 4 Petit Nuage

## Applique fixe 5 Petit Nuage

- |   |  |   |
|---|--|---|
| <b>1</b> Applique suspendue Grand Nuage<br>Large<br>Ref : Asgn    | Abj/Ls : L. 43 x l. 43 x H. 26 cm - Fil textile/Textile cord 1 m/3.3' - Câble acier/Steel cable 2 m/6.6' - 1 x Max 100 W - 230 V : E27 - 120 V : E26 - H. max 130 mm/bulb MOL 5.1" - Non fournie/Not incl.   |                |
| <b>2</b> Applique suspendue Moyen Nuage<br>Medium<br>Ref : Asmn   | Abj/Ls : L. 32 x l. 32 x H. 19 cm - Fil textile/Textile cord 0,75 m/2.5' - Câble acier/Steel cable 2 m/6.6' - 1 x Max 60 W - 230 V : E27 - 120 V : E26 - H. max 115 mm/bulb MOL 4.5" - Non fournie/Not incl. |           |
| <b>3</b> Applique suspendue Petit Nuage<br>Small<br>Ref : Aspnp   | Abj/Ls : L. 24 x l. 24 x H. 16 cm - Fil textile/Textile cord 0,6 m/2.0' - Câble acier/Steel cable 2 m/6.6' - 1 x Max 60 W - 230 V : E14 - 120 V : E12 - H. max 90 mm/bulb MOL 3.5" - Non fournie/Not incl.   |      |
| <b>4</b> Applique tige murale Petit Nuage<br>Small<br>Ref : Atmpn | Abj/Ls : L. 24 x l. 24 x H. 16 cm - Fil textile/Textile cord 0,6 m/2.0' - Câble acier/Steel cable 2 m/6.6' - 1 x Max 60 W - 230 V : E14 - 120 V : E12 - H. max 90 mm/bulb MOL 3.5" - Non fournie/Not incl.   |      |
| <b>5</b> Applique fixe Petit Nuage<br>Small<br>Ref : Apn          | L. 34 x l. 24 x H. 38 cm - Abj/Ls : L. 24 x l. 24 x H. 16 cm<br>1 x Max 60 W - 230 V : E14 - 120 V : E12<br>H. max 90 mm/bulb MOL 3.5" - Non fournie/Not incl.   |      |

Finitions/  
Finishes Voir page 143-149/See page 143-149

Matériaux  
Materials Tissus ou laqué, acier laqué, fil tissé coloré.  
Fabric or lacquered, lacquered steel, colored textile cord.

MADE IN FRANCE

Suspendues / Suspended

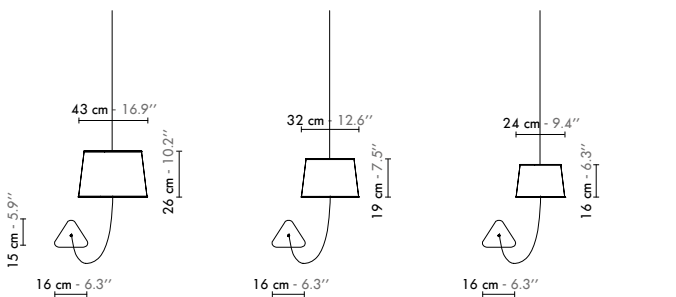

**1** Ref : Asgn



**2** Ref : Asmn



**3** Ref : Aspnp

Tige murale / Fixed rod

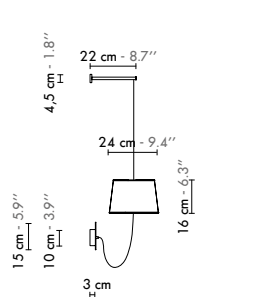

**4** Ref : Atmpn

Fixe / Fixed

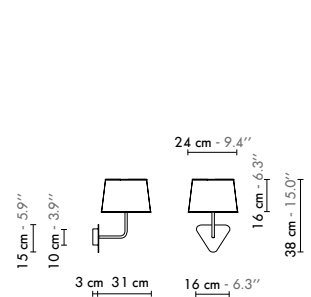

**5** Ref : Apn



1



4

# Nuage

Hervé Langlais

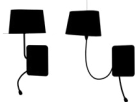













## Applique suspendue liseuse LED ■ Petit Nuage

## Applique murale liseuse LED ■ Petit Nuage



Très décoratives, ces appliques offrent une double source lumineuse : ampoule et liseuse LED. Cette version LED avec double interrupteur est particulièrement recommandée pour une lecture confortable avec ou sans l'éclairage de la lampe principale. Disponible en deux systèmes de fixation avec abat-jour sur tige fixe ou abat-jour suspendu par le câble acier, dans l'esprit nomade, avec réglage de la hauteur souhaitée."

" More than simply ornamental, these lights offer a dual light source: bulb and LED reading light. This LED version with double switch is particularly recommended for comfortable viewing with or without the need to light the main lamp. Available in two mounting systems, with lampshade on a fixed rod or lampshade suspended by a steel cable with adjustable height. "

<b>1</b> Applique suspendue Small Ref : Aspned	Abj/Ls : L. 24 x l. 24 x H. 16 cm - Fil textile/Textile cord 0,6 m/2.0' - Câble acier/Steel cable 2 m/6.6' - LED 1W + 1 x Max 60 W - 230 V : E14 - 120 V : E12 - H. max 90 mm/bulb MOL 3.5'' - Non fournie/Not incl.      
<b>2</b> Applique murale Small Ref : Ampned	Abj/Ls : L. 24 x l. 24 x H. 16 cm - LED 1W + 1 x Max 60 W - 230 V : E14 - 120 V : E12 - H. max 90 mm/bulb MOL 3.5'' - Non fournie/Not incl.      
Finitions/ Finishes	Voir page 143-149/See page 143-149
Matériaux Materials	Tissus ou laqué, acier laqué, fil tissé coloré. Fabric or lacquered, lacquered steel, colored textile cord.

**MADE IN FRANCE**

Suspendue / Suspended

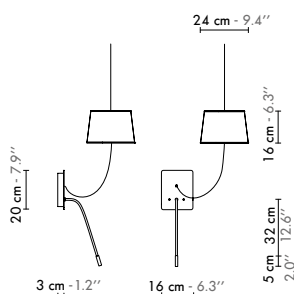

Fixe / Fixed

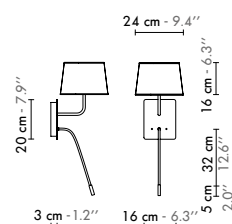

**1** Ref : Aspned

**2** Ref : Ampned





2



1

# Nuage

Hervé Langlais



Suspendu dans les airs par une simple fixation au plafond, ce luminaire a été créé pour s'adapter à tous les espaces. La suspension se branche sur une simple prise et joue le rôle d'un lampadaire ou d'une lampe de chevet en s'affranchissant de l'alimentation électrique au plafond.

Déclinées en quatre tailles, elles peuvent être assemblées en grappe de deux ou trois, à différentes hauteurs, telle une sculpture. "

" Suspended in the air with a single ceiling mount, this light can adapt to fit all environments. The suspended light connects to a simple plug and can play the role of a floor lamp or a bedside lamp, saving the need to require power from the ceiling.



















This version is available in four sizes. Two or three can be combined together, at different heights, like a sculpture. "

## Suspension Nomade ■ XL Nuage

## Suspension Nomade ■ Grand Nuage

## Suspension Nomade ■ Moyen Nuage

## Suspension Nomade ■ Petit Nuage

<b>1</b> Suspension N. XL Nuage XL Ref : Sxln	Abj/Ls : L. 60 x l. 60 x H. 35 cm - Fil textile/Textile cord 3,5 m/11.5' - Câble acier/Steel cable 2 m/6.6' - 1 x Max 100 W - 230 V : E27 - 120 V : E26 H. max 160 mm/bulb MOL 6.3" - Non fournie/Not incl. - Variateur/On-Off switch - Fusible 0,8 A	     850°
<b>2</b> Suspension N. Grand Nuage Large Ref : Sngn	Abj/Ls : L. 43 x l. 43 x H. 26 cm - Fil textile/Textile cord 3,5 m/11.5' - Câble acier/Steel cable 2 m/6.6' - 1 x Max 100 W - 230 V : E27 - 120 V : E26 H. max 130 mm/bulb MOL 5.1" - Non fournie/Not incl. - Variateur/On-Off switch - Fusible 0,8 A	     850°
<b>3</b> Suspension N. Moyen Nuage Medium Ref : Smmn	Abj/Ls : L. 32 x l. 32 x H. 19 cm - Fil textile/Textile cord 3,5 m/11.5' - Câble acier/Steel cable 2 m/6.6' - 1 x Max 60 W - 230 V : E27 - 120 V : E26 - H. max 110 mm/bulb MOL 4.3" - Non fournie/Not incl. - Variateur/On-Off switch - Fusible 0,8 A	     850°
<b>4</b> Suspension N. Petit Nuage Small Ref : Sspn	Abj/Ls : L. 24 x l. 24 x H. 16 cm - Fil textile/Textile cord 3 m/9.8' - Câble acier/Steel cable 2 m/6.6' - 1 x Max 60 W - 230 V : E14 - 120 V : E12 H. max 90 mm/bulb MOL 3.5" - Non fournie/Not incl. - Interrupteur à main/ On-Off switch	     850°
Finitions/ Finishes	Voir page 143-149/See page 143-149	
Matériaux Materials	Tissus ou laqué, acier laqué, fil tissé coloré. Fabric or lacquered, lacquered steel, colored textile cord.	

MADE IN FRANCE

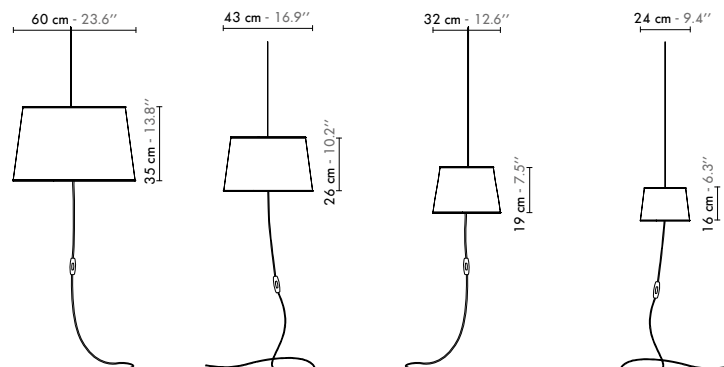

**1** Ref : Sxln



**2** Ref : Sngn



**3** Ref : Smmn



**4** Ref : Sspn



2

3

4





# L'Empirique

Laurent Bailly







## Lampe pupitre ■ L'Empirique



Cette lampe simple, utile, évidente, mais pour autant très élégante, est faite de matériaux de qualité, pour mettre en valeur vos documents. Ces rôles fonctionnels de pupitre et de repose-livre méritaient un bel objet, particulièrement pour présenter photos et courrier comme tous documents personnels et professionnels, ou menus notamment pour un usage en hôtellerie."

" This simple lamp—useful, distinct, but nevertheless elegant—is made of quality materials to beautifully enhance documents. This functional role allows one to showcase photos, organize mail or highlight commercial documents such as brochures, menus or stationary. "

■ Lampe pupitre L'Empirique	L. 33 x l. 20 x H. 42 cm - Cordon/Cord 2 m/6.6' 1 x Max 40 W - 230 V : E14 - 120 V : E12 - Non Fournie/Not Incl.
Ref : Lpe	    
Finitions/ Finishes	Base et cordon transparent/Transparent base and cord Abat-jour blanc ou argent/Lampshade white or silver
Matériaux Materials	Verre acrylique transparent, abat-jour rond en PVC ou abat-jour triangulaire en tissu/Transparent acrylic glass, circle lampshade in PVC or triangular fabric lampshade.

**MADE IN  
FRANCE**

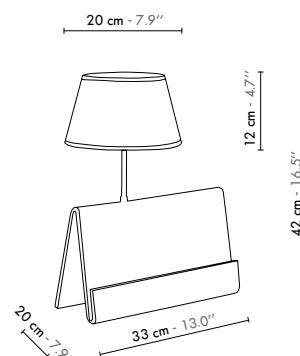



# Nuage

Hervé Langlais



**Suspension ■  
XL Nuage**

**Suspension ■  
Grand Nuage**

**Suspension ■  
Moyen Nuage**

**Suspension ■  
Petit Nuage**



Dans sa forme la plus simple la suspension Nuage est suspendue au plafond par son fil textile de couleur."

" In its simplest form, Nuage pending lamp is suspended from the ceiling by its colored fabric wire."

<b>1</b> Suspension XL Nuage XL Ref : Sgn	Abj/Ls : L. 60 x l. 60 x H. 35 cm - Fil textile/Textile cord 2 m/6.6' 1 x Max 60 W - 230 V : E27 - 120 V : E26 - Non fournie/Not incl.	850° V
<b>2</b> Suspension Grand Nuage Large Ref : Sgn	Abj/Ls : L. 43 x l. 43 x H. 26 cm - Fil textile/Textile cord 2 m/6.6' 1 x Max 60 W - 230 V : E27 - 120 V : E26 - Non fournie/Not incl.	850° V
<b>3</b> Suspension Moyen Nuage Medium Ref : Snn	Abj/Ls : L. 32 x l. 32 x H. 19 cm - Fil textile/Textile cord 2 m/6.6' 1 x Max 60 W - 230 V : E27 - 120 V : E26 - Non fournie/Not incl.	850° V
<b>4</b> Suspension Petit Nuage Small Ref : Spn	Abj/Ls : L. 24 x l. 24 x H. 16 cm - Fil textile/Textile cord 2 m/6.6' 1 x Max 60 W - 230 V : E14 - 120 V : E12 - Non fournie/Not incl.	850° V
Finitions/ Finishes	Voir page 143-149/See page 143-149	
Matériaux Materials	Tissus ou laqué, acier laqué, fil tissé coloré. Fabric or lacquered, lacquered steel, colored textile cord.	

**MADE IN  
FRANCE**

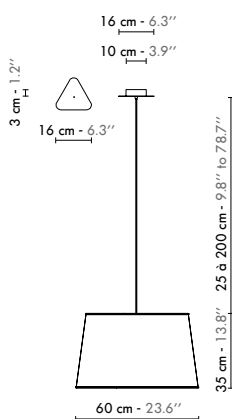

**1** Ref : Sxln

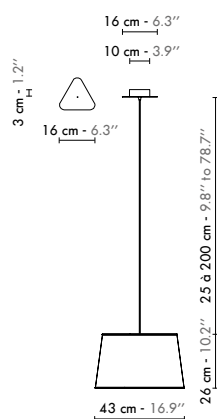

**2** Ref : Sgn

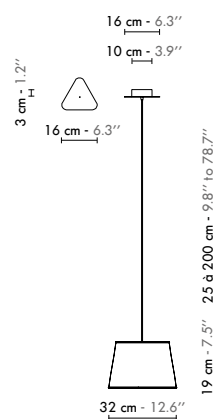

**3** Ref : Snn

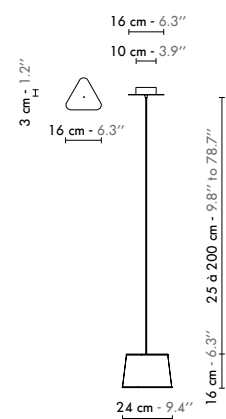

**4** Ref : Spn





2

# Nuage

Hervé Langlais



Dans sa forme la plus simple la suspension Nuage est suspendue au plafond par son fil textile de couleur. Elle est aussi proposée avec un câble acier réglable en hauteur pour être déportée de la source électrique et offrir un caractère plus décoratif."

"In its simplest form, the suspended light Nuage is suspended from the ceiling by its colored fabric wire. It is also available with a steel cable adjustable in height which is set apart from the power source to provide a more decorative character."

## Suspension déportée ■ Grand Nuage

## Suspension déportée ■ Moyen Nuage

## Suspension déportée ■ Petit Nuage

<b>1</b> Suspension déportée Grand Nuage Large Ref : Sdgn	Abj/Ls : L. 43 x l. 43 x H. 26 cm - Fil textile/Textile cord 2 m/6.6' - Câble acier/Steel cable 2 m/6.6' - 1 x Max 100 W - 230 V : E27 - 120 V : E26 H. max 130 mm/bulb MOL 5.1' - Non fournie/Not incl.	     850° V IP 20
<b>2</b> Suspension déportée Moyen Nuage Medium Ref : Sdmm	Abj/Ls : L. 32 x l. 32 x H. 19 cm - Fil textile/Textile cord 2 m/6.6' - Câble acier/Steel cable 2 m/6.6' - 1 x Max 60 W - 230 V : E27 - 120 V : E26 - H. max 110 mm/bulb MOL 4.3' - Non fournie/Not incl.	     850° V IP 20
<b>3</b> Suspension déportée Petit Nuage Small Ref : Sdpm	Abj/Ls : L. 24 x l. 24 x H. 16 cm - Fil textile/Textile cord 2 m/6.6' - Câble acier/Steel cable 2 m/6.6' - 1 x Max 60 W - 230 V : E14 - 120 V : E12 - H. max 90 mm/bulb MOL 3.5' - Non fournie/Not incl.	     850° V IP 20
<b>Finitions/ Finishes</b> Voir page 143-149/See page 143-149		
<b>Matériaux Materials</b> Tissus ou laqué, acier laqué, fil tissé coloré. Fabric or lacquered, lacquered steel, colored textile cord.		

**MADE IN FRANCE**

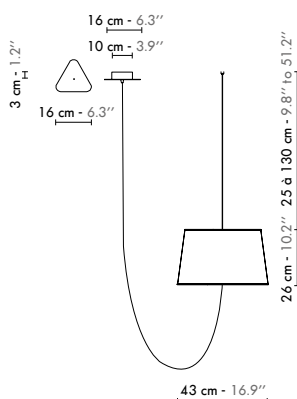

**1** Ref : Sdgn

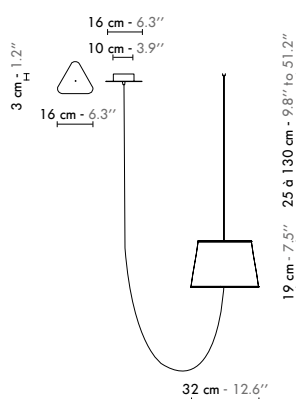

**2** Ref : Sdmm

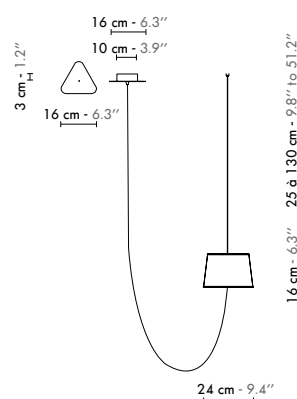

**3** Ref : Sdpm







# Nuage

Hervé Langlais



Pour une diffusion confortable de la lumière, cette très grande suspension est équipée d'un diffuseur inférieur en verre acrylique satiné opale.















Disponible en un seul coloris en standard, blanc bordé de noir."

" For a comfortable light dispersion, this oversized variation is equipped with a lower diffuser in satin opal acrylic glass."

Available in one standard color only : white rimmed with a black border."

## Suspension ■ XXL Nuage

## Suspension ■ XXL Flat Nuage

<b>1</b> Suspension XXL Nuage Ref : Sxxlnbbn	<b>Hauteur sous plafond min 3 m/Ceiling height min 10'</b> Abj/Ls : L. 116 x l. 116 x H. 65 cm - Fil textile/Textile cord 2 m/6.6' - Câble acier/Steel cable 3 x 2 m/3 x 6.6' 4 x Max 60 W - 230 V : E27 - 120 V : E26 - Non fournie/Not incl.
      	
<b>2</b> Suspension XXL Flat Nuage Ref : Sxxlflatnbn	<b>Hauteur sous plafond min 2,7 m/Ceiling height min 9'</b> Abj/Ls : L. 116 x l. 116 x H. 40 cm - Fil textile/Textile cord 2 m/6.6' - Câble acier/Steel cable 3 x 2 m/3 x 6.6' 4 x Max 60 W - 230 V : E27 - 120 V : E26 - Non fournie/Not incl.
      	
<b>Finitions/ Finishes</b>	<b>Blanc diffusant - bordure noire/White diffusing - black border.            Sur-mesure sur demande/Custom made color on request.</b>
<b>Matériaux Materials</b>	<b>Tissus ou laqué, acier laqué, verre acrylique satiné, fil tissé coloré/Fabric            or lacquered, lacquered steel, satin opal acrylic glass, colored textile            cord.</b>

**MADE IN  
FRANCE**

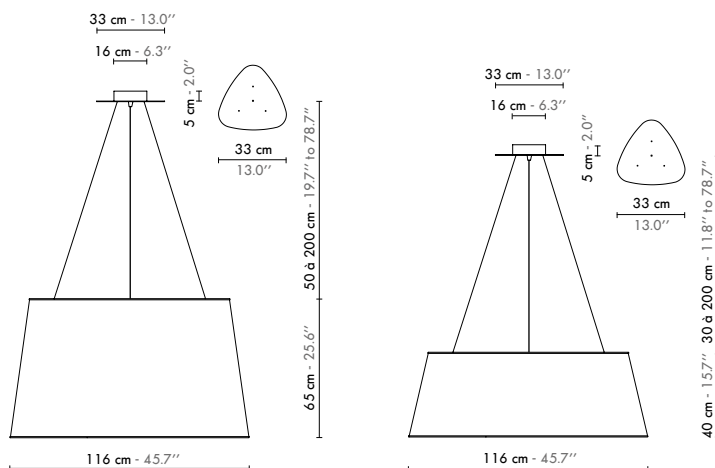

**1** Ref : Sxxlnbbn



**2** Ref : Sxxlflatnbn



1

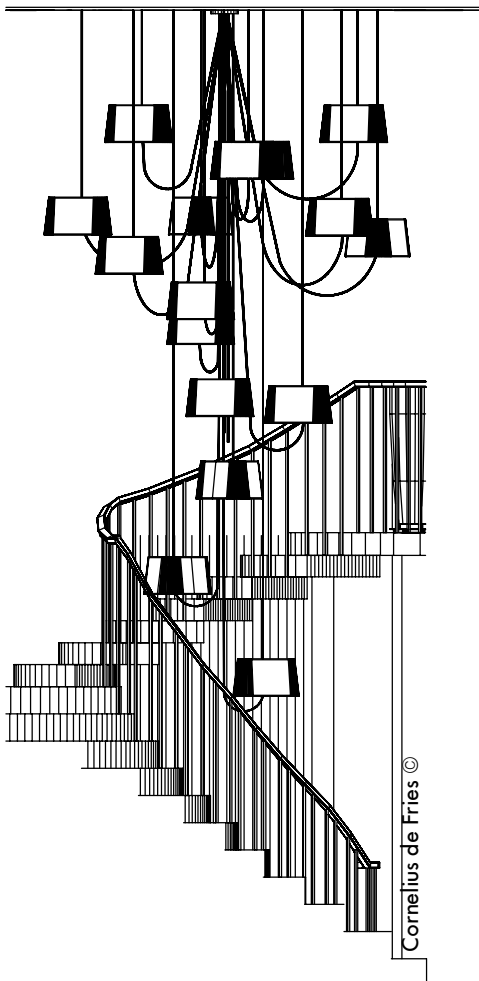

## Lustres



Esprit nomade et poétique pour ce magnifique **lustre**. Aérien et ultra léger, il semble flotter dans les airs. Fixés sur des câbles en acier, les abat-jour peuvent être montés ou descendus à volonté grâce à un piston situé sur leur partie supérieure. Modulable en hauteur, ce lustre est aussi ajustable en diamètre total et en forme selon la distance choisie entre les abat-jour. Situés sous les abat-jour, les fils textiles colorés sont aussi des éléments décoratifs. Disponible en trois tailles et trois modèles à choisir en fonction des hauteurs de plafond.”

“ A free and poetic spirit describes the magnificent **chandelier**, Lustres. Soaring and ultra light, it appears to float in the air. Attached to steel cables, the shades can be raised or lowered as needed using a piston mechanism situated on the top. Along with being adjustable in height, the chandelier is also adjustable in diameter and shape depending on the placement of the lampshades. Located under the lampshades, colored textile cords also serve as decorative elements. Available in three sizes and three models depending on ceiling height. “





# Collection Nuage - LUSTRES

Design : Hervé Langlais



# Nuage

Hervé Langlais

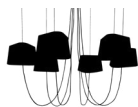

## Lustre 6 Grand Nuage ■

## Lustre 6 Moyen Nuage ■

## Lustre 6 Petit Nuage ■



### Dimensions du lustre : ajustement

La hauteur du lustre dépend de votre hauteur sous plafond, de la hauteur de passage souhaitée et de l'usage du lieu. Sur demande, notre atelier ajuste les longueurs de fils et de câbles.

Voir page 124-127

### Dimensions of the chandelier : Adjustment

The height of the chandelier depends on ceiling height, the desired headroom and the use of the place. On request, our workshop will adjust the cords and cables.

See page 124-127

**1** Lustre 6 Grand Nuage  
Large  
Ref : Luógn  
Hauteur sous plafond de 2,7 à 4,1 m / Ceiling height from 9' to 12'  
Ø 203 cm x H. 180 cm - Abj/Ls : L. 43 x l. 43 x H. 26 cm - Fil textile/Textile cord 6 x 2,5 m/6 x 8.2' - Câble acier/Steel cable 6 x 2 m/6 x 6.6' 6 x Max 100 W - 230 V : E27 - 120 V : E26 - H. max 130 mm/bulb MOL 5.1'' - Non fournie/Not incl.



**2** Lustre 6 Moyen Nuage  
Medium  
Ref : Luómn  
Hauteur sous plafond de 2,5 à 3,6 m / Ceiling height from 8' to 10'  
Ø 152 cm x H. 130 cm - Abj/Ls : L. 32 x l. 32 x H. 19 cm - Fil textile/Textile cord 6 x 1,9 m/6 x 6.2' - Câble acier/Steel cable 6 x 2 m/6 x 6.6' 6 x Max 60 W - 230 V : E27 - 120 V : E26 - H. max 115 mm/bulb MOL 4.5'' - Non fournie/Not incl.



**3** Lustre 6 Petit Nuage  
Small  
Ref : Luópn  
Hauteur sous plafond de 2,3 à 3,5 m / Ceiling height from 8' to 9'  
Ø 94 cm x H. 115 cm - Abj/Ls : L. 24 x l. 24 x H. 16 cm - Fil textile/Textile cord 6 x 1,5 m/6 x 4.9' - Câble acier/Steel cable 6 x 2 m/6 x 6.6' 6 x Max 60 W - 230 V : E14 - 120 V : E12 - H. max 90 mm/bulb MOL 3.5'' - Non fournie/Not incl.



Finitions/ Finishes Voir page 143-149/See page 143-149

Matériaux Materials Tissus percaline ou laqué, acier laqué, fil tissé coloré. Fabric or lacquered, lacquered steel, colored textile cord.

Lustre réglable Adjustable chandelier Hauteur et diamètre réglables - 1 ou 2 niveaux - Possibilité d'ajout de longueurs de fils et câbles/Choice of height and diameter - Ability to add lengths of cords and cables.

MADE IN FRANCE

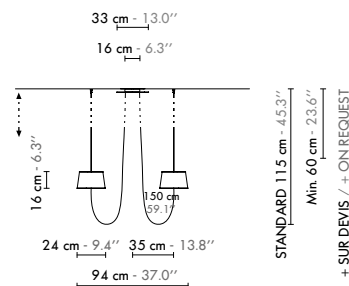
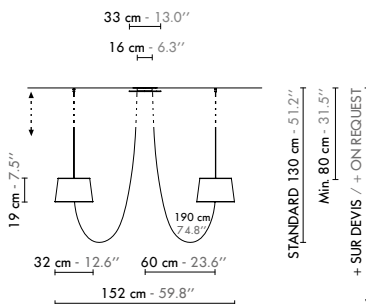
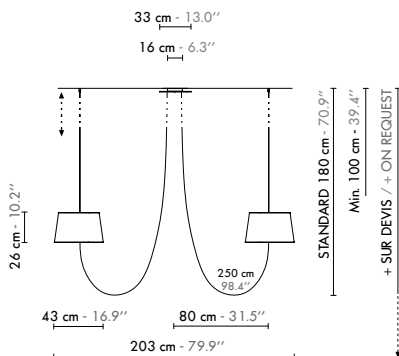
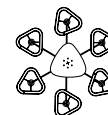

**1** Ref : Luógn

**2** Ref : Luómn

**3** Ref : Luópn





# Nuage

Hervé Langlais

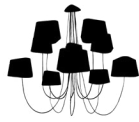

## Lustre 10 Grand Nuage ■

## Lustre 10 Moyen Nuage ■

## Lustre 10 Petit Nuage ■



### Dimensions du lustre : ajustement

La hauteur du lustre dépend de votre hauteur sous plafond, de la hauteur de passage souhaitée et de l'usage du lieu. Sur demande, notre atelier ajuste les longueurs de fils et de câbles.

Voir page 124-127

### Dimensions of the chandelier : Adjustment

The height of the chandelier depends on ceiling height, the desired headroom and the use of the place. On request, our workshop will adjust the cords and cables.

See page 124-127

**1** Lustre 10 Grand Nuage  
Large  
Ref : Lu10gn  
Hauteur sous plafond de 3,0 à 4,4 m / Ceiling height from 10' to 13'  
Ø 223 cm x H. 210 cm - Abj/Ls : L. 43 x l. 43 x H. 26 cm - Fil textile/Textile cord 5 x 2.3/5 x 2.9 m/5 x 7.5'/5 x 9.5' - Câble acier/Steel cable 10 x 2 m/10 x 6.6' - 10 x Max 100 W - 230 V : E27 - 120 V : E26 - H. max 130 mm/bulb MOL 5.1'' - Non fournie/Not incl.



**2** Lustre 10 Moyen Nuage  
Medium  
Ref : Lu10mn  
Hauteur sous plafond de 2,8 à 3,8 m / Ceiling height from 9' to 11'  
Ø 182 cm x H. 150 cm - Abj/Ls : L. 32 x l. 32 x H. 19 cm - Fil textile/Textile cord 5 x 1,7/5 x 2,2 m/5 x 5.6'/5 x 7.2' - Câble acier/Steel cable 10 x 2 m/10 x 6.6' - 10 x Max 60 W - 230 V : E27 - 120 V : E26 - H. max 115 mm/bulb MOL 4.5'' - Non fournie/Not incl.



**3** Lustre 10 Petit Nuage  
Small  
Ref : Lu10pn  
Hauteur sous plafond de 2,5 à 3,6 m / Ceiling height from 8' to 10'  
Ø 134 cm x H. 130 cm - Abj/Ls : L. 24 x l. 24 x H. 16 cm - Fil textile/Textile cord 5 x 1,4/5 x 1,8 m/5 x 4.6'/5 x 5.9' - Câble acier/Steel cable 10 x 2 m/10 x 6.6' - 10 x Max 60 W - 230 V : E14 - 120 V : E12 - H. max 90 mm/bulb MOL 3.5'' - Non fournie/Not incl.



Finitions/ Finishes Voir page 143-149/See page 143-149

Matériaux Materials Tissus ou laqué, acier laqué, fil tissé coloré. Fabric or lacquered, lacquered steel, colored textile cord.

Lustre réglable Adjustable chandelier Hauteur et diamètre réglables - 1 ou 2 niveaux - Possibilité d'ajout de longueurs de fils et câbles/Choice of height and diameter - 1 or 2 levels - Ability to add lengths of cords and cables.

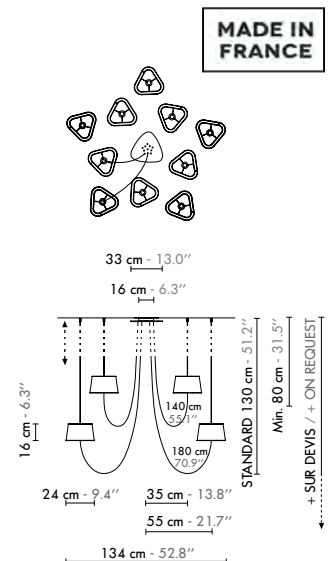
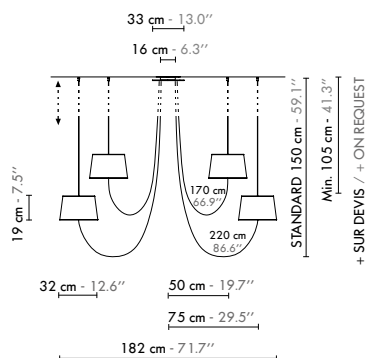
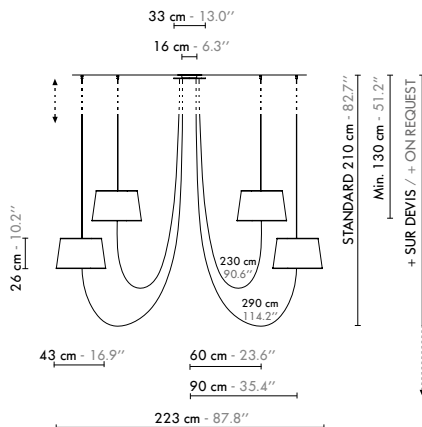

MADE IN FRANCE

**1** Ref : Lu10gn

**2** Ref : Lu10mn

**3** Ref : Lu10pn



1



# Nuage

Hervé Langlais

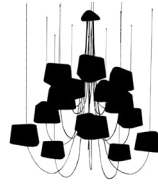

## Lustre 15 Grand Nuage 1

## Lustre 15 Moyen Nuage 2

## Lustre 15 Petit Nuage 3



### Dimensions du lustre : ajustement

La hauteur du lustre dépend de votre hauteur sous plafond, de la hauteur de passage souhaitée et de l'usage du lieu. Sur demande, notre atelier ajuste les longueurs de fils et de câbles.

Voir page 124-127

### Dimensions of the chandelier : Adjustment

The height of the chandelier depends on ceiling height, the desired headroom and the use of the place. On request, our workshop will adjust the cords and cables.

See page 124-127

- 1** Lustre 15 Grand Nuage  
Large  
Ref : Lu15gn

Hauteur sous plafond de 3,3 à 4,8 m / Ceiling height from 11' to 14'  
Ø 243 cm x H. 250 cm - Abj/Ls : L. 43 x l. 43 x H. 26 cm - Fil textile/  
Textile cord 5 x 2.15/5 x 2,7/5 x 3,35 m/5 x 7.1'/5 x 8.9'/5 x 11'  
Câble acier/Steel cable 15 x 2 m/15 x 6.6' - 15 x Max 100 W - 230 V :  
E27 - 120 V : E26 - H. max 130 mm/bulb MOL 5.1" - Non fournie/Not incl.



- 2** Lustre 15 Moyen Nuage  
Medium  
Ref : Lu15mn

Hauteur sous plafond de 3,0 à 4,1 m / Ceiling height from 10' to 12'  
Ø 192 cm x H. 180 cm - Abj/Ls : L. 32 x l. 32 x H. 19 cm - Fil textile/  
Textile cord 5 x 1,5/5 x 2/5 x 2,5 m/5 x 4.9'/5 x 6.6'/5 x 8.2' - Câble  
acier/Steel cable 15 x 2 m/15 x 6.6' - 15 x Max 60 W - 230 V : E27  
- 120 V : E26 - H. max 115 mm/bulb MOL 4.5" - Non fournie/Not incl.



- 3** Lustre 15 Petit Nuage  
Small  
Ref : Lu15pn

Hauteur sous plafond de 2,7 à 3,8 m / Ceiling height from 9' to 11'  
Ø 174 cm x H. 150 cm - Abj/Ls : L. 24 x l. 24 x H. 16 cm - Fil textile/  
Textile cord 5 x 1,3/5 x 1,7/5 x 2,1 m/5 x 4.3'/5 x 5.6'/5 x 6.9' - Câble  
acier/Steel cable 15 x 2 m/15 x 6.6' - 15 x Max 60 W - 230 V : E14 - 120 V :  
E12 - H. max 90 mm/bulb MOL 3.5" - Non fournie/Not incl.



Finitions/Finishes Voir page 143-149/See page 143-149

Matériaux Tissus ou laqué, acier laqué, fil tissé coloré.  
Materials Fabric or lacquered, lacquered steel, colored textile cord.

Lustre réglable Hauteur et diamètre réglables - 2 ou 3 niveaux - Possibilité d'ajout de  
Adjustable chandelier Adjustable height and diameter - 2 or 3 levels - Ability to add lengths of cords and cables.

MADE IN FRANCE

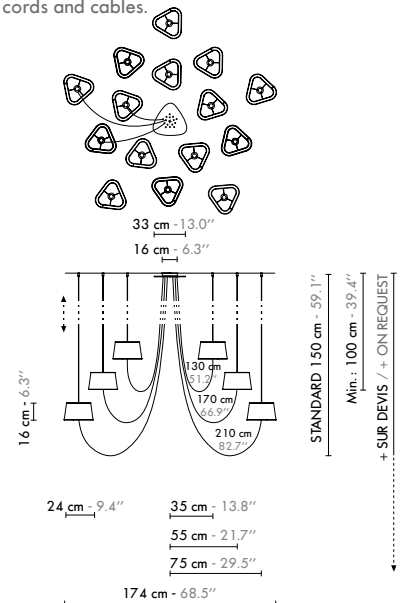
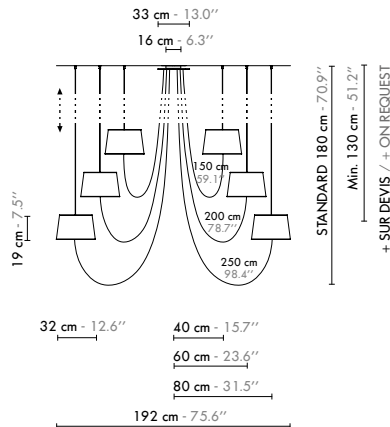
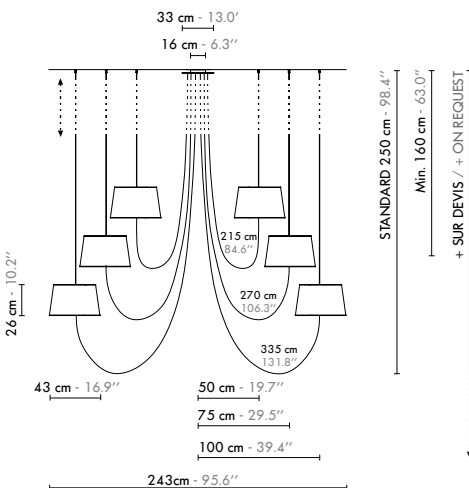





# Préconisations de hauteur de lustre

Dimensions du lustre :  Ajustement

Notre atelier peut ajuster les longueurs de fils :

La hauteur du lustre dépend de votre hauteur sous plafond, de la hauteur de passage souhaitée et de l'usage du lieu.

- La réduction de fil est un service compris dans le prix.
- L'ajout de mètre supplémentaire est un service supplémentaire.

## Lustre Grand Nuage

LUSTRE 15 GRAND NUAGE

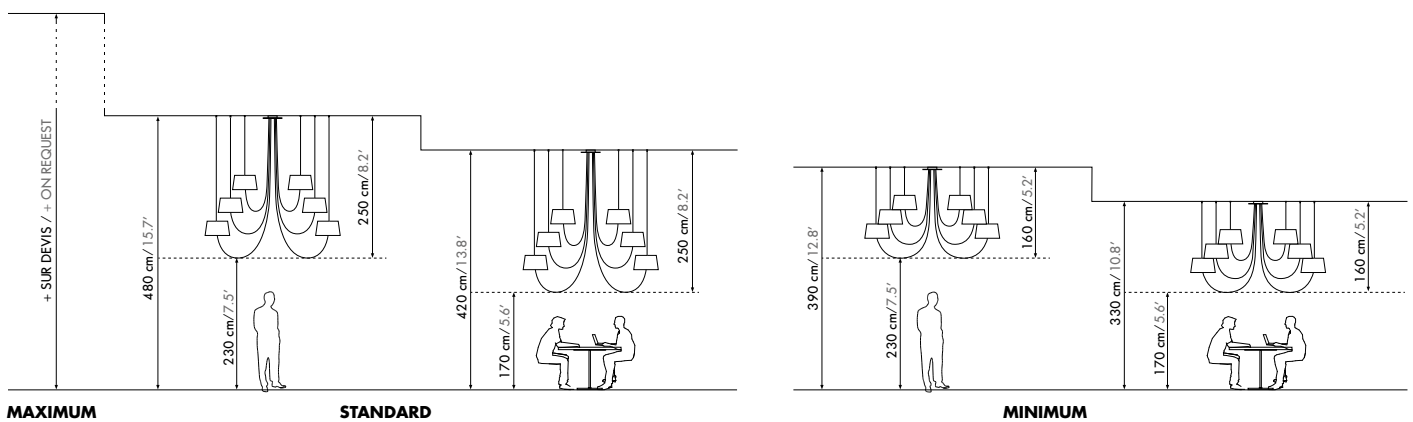

LUSTRE 10 GRAND NUAGE

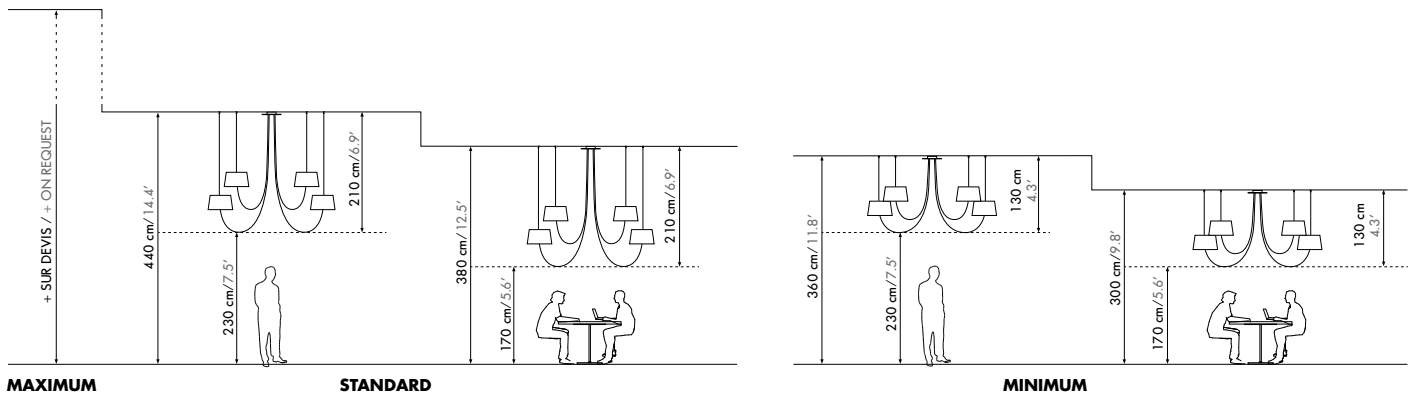

LUSTRE 6 GRAND NUAGE

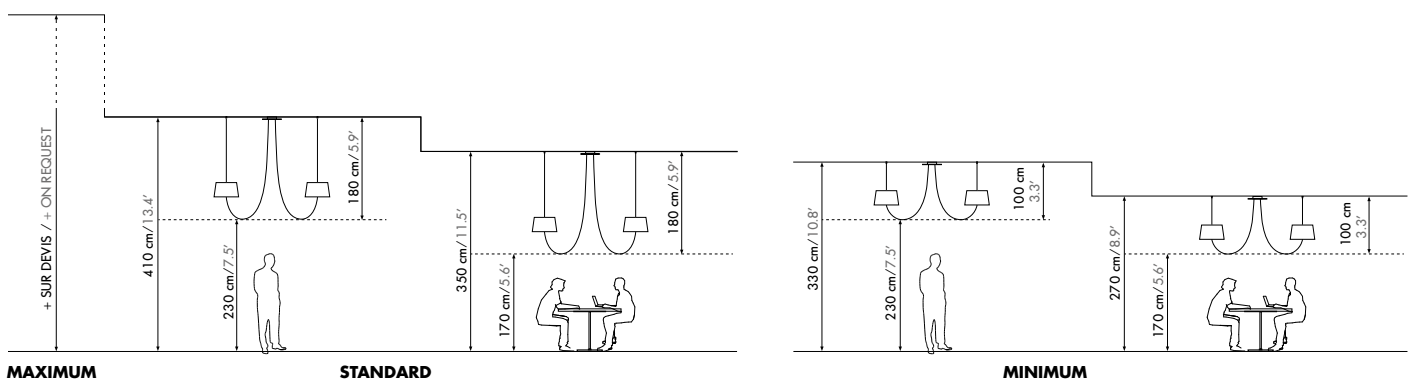

# Recommended chandelier height

## Dimensions of the chandelier : Adjustment

The height of the chandelier depends on ceiling height, the desired height of passage and the use of the place.

## Our workshop can adjust the length of cords:

- The reduction of cords is inclusive of service charges in the price.
- The addition of cords will generate extra charges.

## Lustre Moyen Nuage

### LUSTRE 15 MOYEN NUAGE

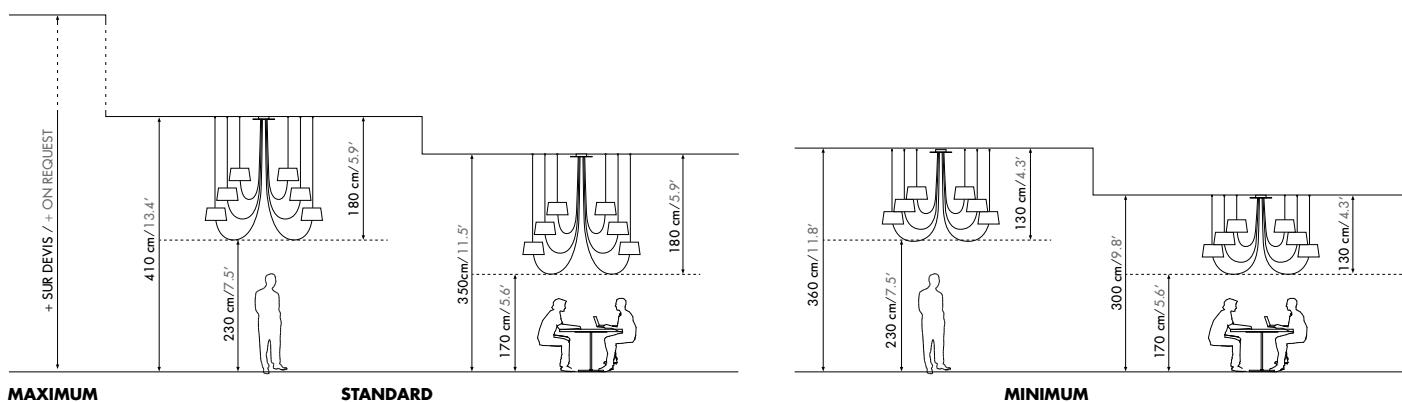

### LUSTRE 10 MOYEN NUAGE

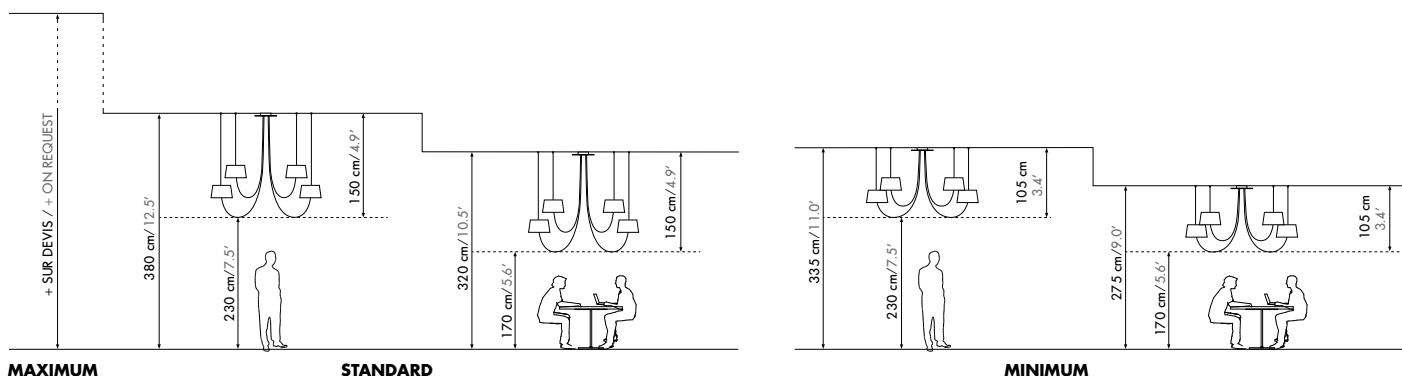

### LUSTRE 6 MOYEN NUAGE

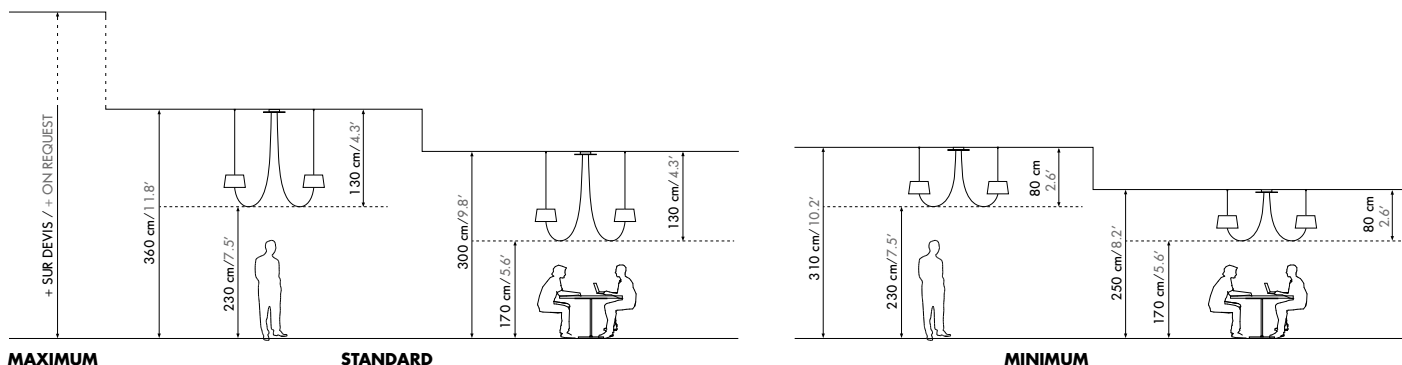



# Préconisations de hauteur de lustre

## Recommended chandelier height

### Dimensions du lustre : Ajustement

La hauteur du lustre dépend de votre hauteur sous plafond, de la hauteur de passage souhaitée et de l'usage du lieu.

#### Notre atelier peut ajuster les longueurs de fils :

- La réduction de fil est un service compris dans le prix.
- L'ajout de mètre additionnel est un service supplémentaire.

### Dimensions of the chandelier : Adjustment

The height of the chandelier depends on ceiling height, the desired height of passage and the use of the place.

#### Our workshop can adjust the length of cords:

- The reduction of cords is inclusive of service charges in the price.
- The addition of cords will generate extra charges.

## Lustre Petit Nuage

### LUSTRE 15 PETIT NUAGE

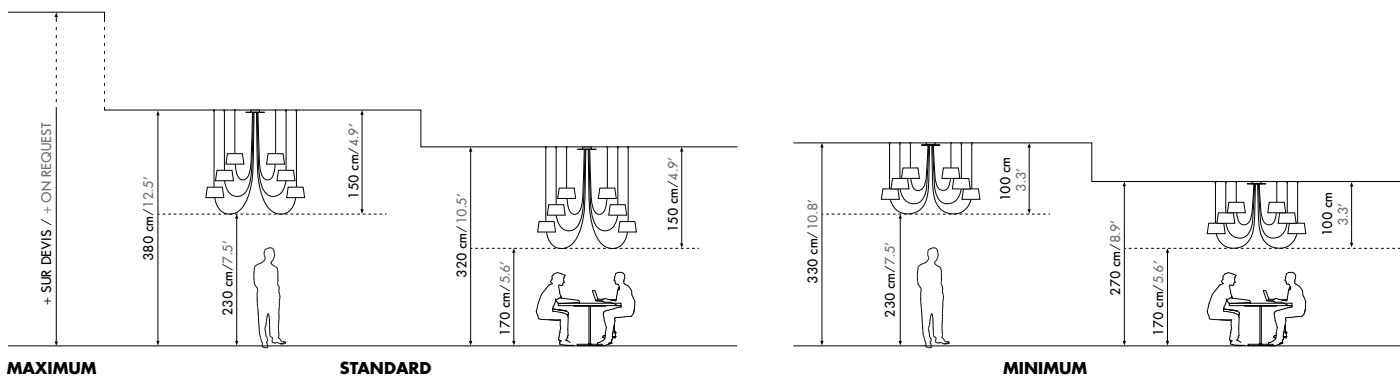

### LUSTRE 10 PETIT NUAGE

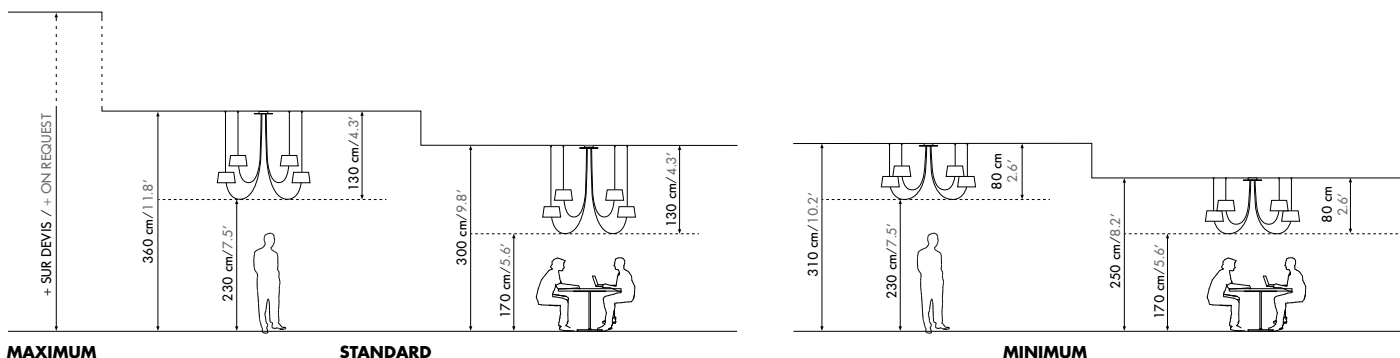

### LUSTRE 6 PETIT NUAGE

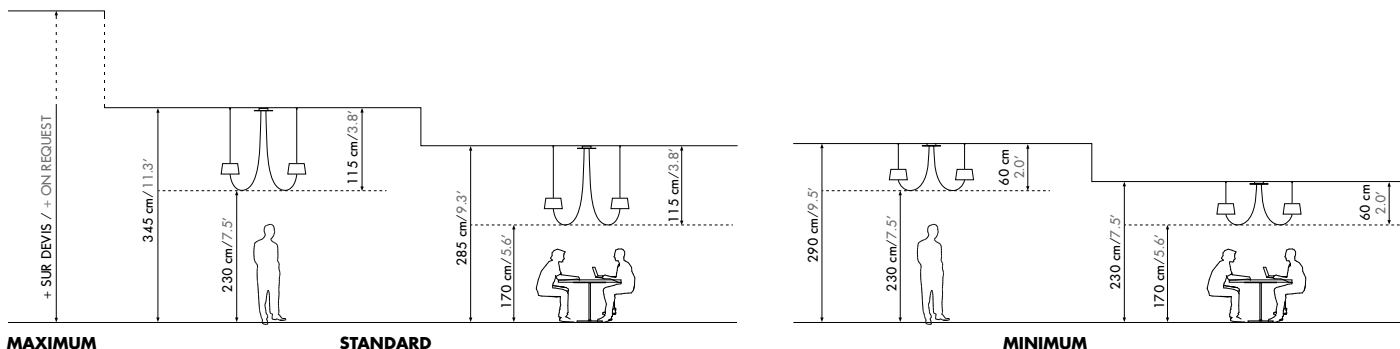



# Lightbook

Hervé Langlais



## Lampe de bibliothèque ■ Lightbook



Sa structure légère et plate se glisse sous ses livres préférés et se déplace au gré de ses recherches. Créée pour mettre en valeur sa bibliothèque avec plusieurs points lumineux, la Lightbook procure selon le choix de l'abat-jour, une lumière diffusante ou structurante."

" Lightbook's lightweight and flat design can slide simply over your favorite books or moved around to your preference. It is designed to showcase bookshelves through multiple points of light, providing a scattered or more focused light, depending the choice of shade. "

■ Lampe de bibliothèque  
Lightbook  
Ref : LlB

L. 34 x l. 10 x H. 12 cm - Abj/Ls : Ø 10 x H. 12 cm - Fil textile/Textile cord  
3 m/9.8' - 1 x Max 15 W - 230 V : E14 - 120 V : E12 - Non certifié ETL/  
Uncertified ETL - H. max 90 mm /bulb MOL 3.5" - Non fournie/Not incl.



Finitions/  
Finishes

Voir page 143-149/See page 143-149

Matériaux  
Materials

Tissus, acier laqué, fil tissé coloré.  
Fabric, lacquered steel, colored textile cord.

MADE IN  
FRANCE

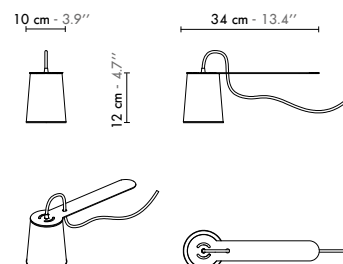



FRANK LLOYD WRIGHT  
LE CORBUSIER  
GIO PONTI  
TASCHEN  
TASCHEN  
TASCHEN

IDEAT DOH (D) 4,50 € / TCM (D) 900 CDF / Andora 5 € / Belgique 5,50 € / Lux. 5,00 € / Suisse FS 10 / Autriche 8,00 € / Allemagne 10,00 € / Espagne 8,00 € / Portugal 6,50 € / UK 6,40 / Canada CAD 10,00 / Japon ¥ 2900  
IDEAT DOH (D) 4,50 € / TCM (D) 900 CDF / Andora 5 € / Belgique 5,50 € / Lux. 5,00 € / Suisse FS 10 / Autriche 8,00 € / Allemagne 10,00 € / Espagne 8,00 € / Portugal 6,50 € / UK 6,40 / Canada CAD 10,00 / Japon ¥ 2900  
IDEAT DOH (D) 4,50 € / TCM (D) 900 CDF / Andora 5 € / Belgique 5,50 € / Lux. 5,00 € / Suisse FS 10 / Autriche 8,00 € / Allemagne 10,00 € / Espagne 8,00 € / Portugal 6,50 € / UK 6,40 / Canada CAD 10,00 / Japon ¥ 2900  
IDEAT DOH (D) 4,50 € / TCM (D) 900 CDF / Andora 5 € / Belgique 5,50 € / Lux. 5,00 € / Suisse FS 10 / Autriche 8,00 € / Allemagne 10,00 € / Espagne 8,00 € / Portugal 6,50 € / UK 6,40 / Canada CAD 10,00 / Japon ¥ 2900  
IDEAT DOH (D) 4,50 € / TCM (D) 900 CDF / Andora 5 € / Belgique 5,50 € / Lux. 5,00 € / Suisse FS 10 / Autriche 8,00 € / Allemagne 10,00 € / Espagne 8,00 € / Portugal 6,50 € / UK 6,40 / Canada CAD 10,00 / Japon ¥ 2900  
IDEAT DOH (D) 4,50 € / TCM (D) 900 CDF / Andora 5 € / Belgique 5,50 € / Lux. 5,00 € / Suisse FS 10 / Autriche 8,00 € / Allemagne 10,00 € / Espagne 8,00 € / Portugal 6,50 € / UK 6,40 / Canada CAD 10,00 / Japon ¥ 2900



# IDEAT

CONTEMPORARY LIFE

SPÉCIAL ARCHITECTURE

5 nouveaux it-musées  
Munich, reine de l'urbanisme  
10 projets pour réinventer Paris  
Yener Torun, le dédic  
Aravena, un Pritzker à Venise  
Hommage à Zaha Hadid  
10 expos incontournables  
Palm Springs, cultissime

M 02689 TH - P - 9,90 € - FR

Hors-série architecture n° 7 - Juin 2016 - 9,90 €

IDEAT  
CONTEMPORARY LIFE  
SPÉCIAL ARCHITECTURE  
ville idéale ?  
nouvelle biennale à Chicago  
d'Elleen Gray  
suscitée  
d'architecte à découvrir



# Lightbook

Designheure studio

## Suspension ■ Lightbook



Créée pour mettre en valeur les tableaux ou marquer un couloir lumineux, la suspension Lightbook procure une lumière intimiste et raffinée."

" Created to showcase paintings or illuminate a hallway, the pendant version of Lightbook provides an intimate and refined ambiance. "

■ Suspension  
Lightbook  
Ref : Slb

Abj/Ls : Ø 10 x H. 12 cm - Fil textile/Textile cord 1 m/3.3' - 1 x Max 15 W - 230 V : E14 - 120 V : E12 - Non certifié ETL/Uncertified ETL  
H. max 90 mm/bulb MOL 3.5" - Non fournie/Not incl.



Finitions/  
Finishes

Voir page 143-149/See page 143-149

Matériaux  
Materials

Tissus, acier laqué, fil tissé coloré.  
Fabric, lacquered steel, colored textile cord.

MADE IN FRANCE









# Lightbook

Designheure studio



## Applique ■ Lightbook

### //

Une silhouette graphique, courbe et douce pour cette petite applique à la fois discrète et élégante. Créée pour être branchée sur une simple prise, l'applique Lightbook peut se fixer au mur, contre une tête de lit ou posée à cheval et procure selon le choix de l'abat-jour, une lumière diffusante ou structurante."

" The graphic curve and sweet silhouette of the Lightbook wall lamp is both discrete and elegant. Created to be simply connected to a wall socket, this model can be fixed to a wall or headboard, providing a scattering or more structured focused light, depending on choice of shade. "

#### ■ Applique Lightbook Ref : Alb

L. 21 x l. 10 x H. 14 cm - Abj/Ls : Ø 10 x H. 12 cm - Fil textile avec interrupteur et prise / Textile cord with switch and plug 3 m/9.8' 1 x Max 15 W - 230 V : E14 - 120 V : E12 - Non certifié ETL/Uncertified ETL - H. max 90 mm /bulb MOL 3.5" - Non fournie/Not incl.



#### Finitions/ Finishes

Voir page 143-149/See page 143-149

#### Matériaux Materials

Tissus, acier laqué, fil tissé coloré.  
Fabric, lacquered steel, colored textile cord.

**MADE IN  
FRANCE**

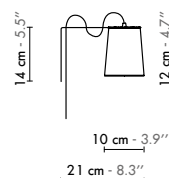



# Nonne/Prima

Raoul Raba / Rééditions



Lampe à poser ■  
Nonne D-625

Applique ■  
Prima













## //

Nonne - Réalisée à partir d'un disque de tôle, la "D-625" ou "Nonne", offre un mouvement indiscutable. Le piétement et l'abat-jour réalisés à partir d'une même pièce, se confondent, se complètent, dans une remarquable fluidité.

" Made from a single metal disk, the "D-625" or "Nonne", displays undeniable movement. The base and the lampshade overlap and complement each other with a remarkable fluidity. "

Prima - "Applique de grande dimension en acier peinte à l'époxy. Son design organique aux formes d'algues marines surprend par son originalité et offre une présence toute singulière, éclairée comme éteinte."

" A grand wall light in steel epoxy paint, Prima's organic seaweed design is original and a singular presence wither lit or unlit. "

<b>1</b> Lampe Nonne D-625 Ref : Ld625	L. 55 x l. 35 x H. 30 cm - Fil textile/Textile cord 2 m/6.6' - Ampoule calotte argentée/Silver crown bulb 1 x Max 60 W - 230 V : E27 - 120 V : E26 - Non Fournie/Not Incl. Ref : Ld625	     
<b>Finitions/ Finishes</b>	Blanc - fil blanc/White - white cord	
<b>Matériaux Materials</b>	Acier laqué, fil tissé coloré/Lacquered steel, colored textile cord.	
<b>MADE IN FRANCE</b>		
<b>2</b> Applique Prima Ref : Ampg	L. 100 x l. 9 x H. 90 cm - Alimentation/Cord 2 m/6.6' - 1 x Max 100 W - 230 V : E27 - 120 V : E26 - Non Fournie/Not Incl. Ref : Ampg	     
<b>Finitions/ Finishes</b>	Laiton - Cordon transparent/Brass - transparent cord	
<b>Matériaux Materials</b>	Acier émaillé peint/Painted steel.	
<b>MADE IN FRANCE</b>		

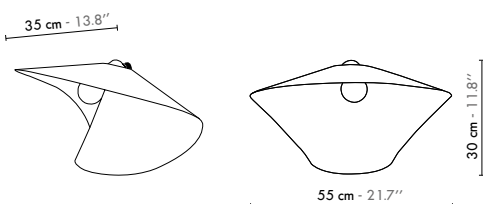

1 Ref : Ld625

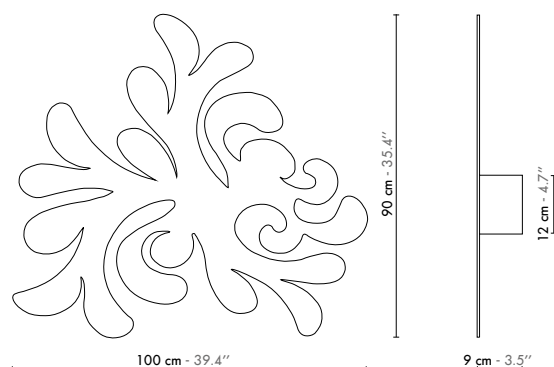

1 Ref : Ampg





2



1

# E60

Raoul Raba



## Suspension ■ E60



Plus de 40 ans après sa création, cette suspension reste un défi intellectuel et formel. Ses 60 éléments de Polyéthylène satinés assemblés telles des fractales, confèrent à ce luminaire un aspect singulier. Raoul Raba fit un voyage dans le «Space - Age» et en ramena cette fleur spatiale et mécanique...”

“ More than 40 years after its creation, “E60” remains an intellectual and formal challenge. The light receives its singular impact from 60 glossy polyethylene elements assembled as fractals. Raoul Raba explored a day in the Space Age and brought back this spatial and futuristic flower. ”

■ Suspension E60 Ø 65 cm - Alimentation/Cord 2 m / 6.6' - 1 x Max 60 W - 230 V : E27 - 120 V : E26 - Ampoule LED équivalent 150 W fournie sauf E26/LED bulb 150 W incl. except E26.

Ref : Se60b



Finitions/ Finishes Blanc - Fil pvc blanc/White - White pvc cord.

Matériaux Materials Polyéthylène opale, finition brillante/Opal polyethylene, glossy finish.

**MADE IN FRANCE**

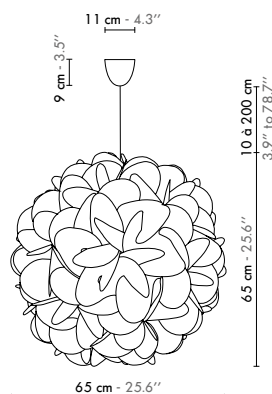

■ Ref : Se60b







# Radiolaire

Raoul Raba















## Suspension ■ Radiolaire

## Lampe à poser ■ Radiolaire



Dessinée en 1968 par Raoul Raba, la structure lumineuse Radiolaire est un bel exemple d'art décoratif. Un savant tressage d'éléments en matière plastique mate, pour une fleur de lumière à l'aspect sculptural et à l'éclairage velouté. Produites en France en petites séries avec un mode de fabrication alliant petite industrie et artisanat d'art, "Les structures-lumières" nous font remonter aux sources du design contemporain."

" Designed by Raoul Raba in 1968, "Radiolaire" is an excellent example of decorative art. A clever braiding of matte plastic elements creates a sculptural "flower" of light with velvety lighting overtones. Produced in France in a limited series using a manufacturing method similar to a small craft artisan, this "structures-light" take us back to the roots of contemporary design."

1 Suspension Radiolaire Ref : Sr50b	Ø 50 cm - Alimentation/Cord 2 m/6.6' - 1 x Max 60 W - 230 V : E27 120 V : E26 - Ampoule LED équivalent 100 W fournie sauf E26/LED bulb 100 W incl. except E26.	     850' 
2 Lampe Radiolaire Ref : Lr50b	Ø 50 cm x H. 60 cm - Alimentation/Cord 2 m/6.6' - 1 x Max 60 W 230 V : E27 - 120 V : E26 - Ampoule LED équivalent 100 W fournie sauf E26/LED bulb 100 W incl. except E26.	     850' 
Finitions/ Finishes	Blanc - Fil pvc blanc/White - White pvc cord.	
Matériaux Materials	Polycarbonate, acier laqué/Polycarbonate, lacquered steel.	

MADE IN  
FRANCE

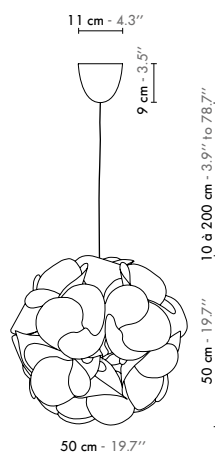

1 Ref : Sr50b

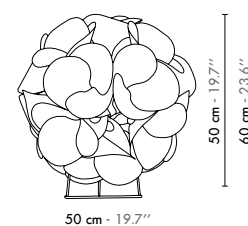

2 Ref : Lr50b

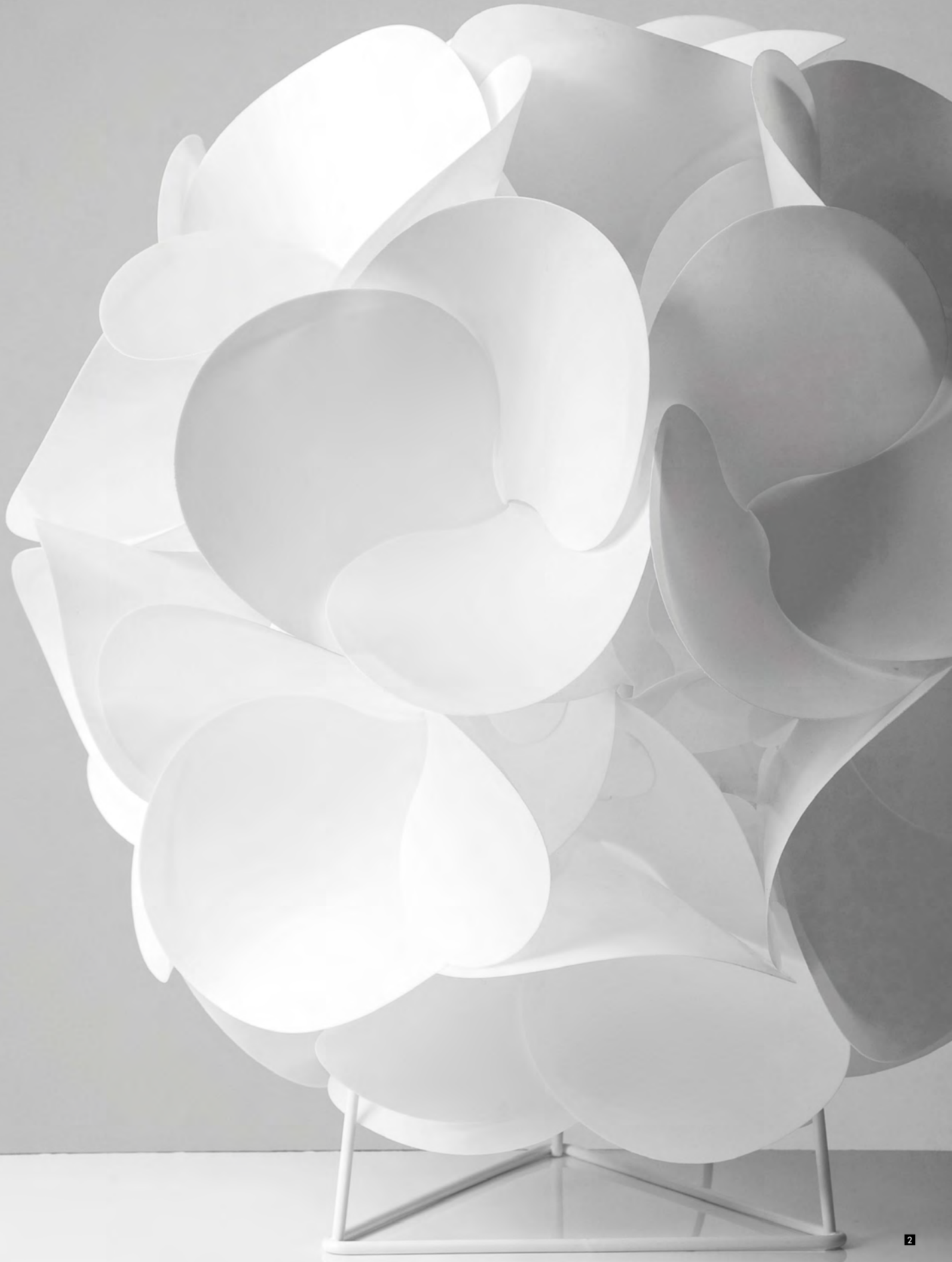

# Miss Scope

Hervé Langlais



A l'origine, cette lampe est née d'un détournement du projecteur industriel vers le luminaire design. Véritable lampe de table, elle projette aussi le motif de votre choix, créant une fenêtre lumineuse. Projette de façon interchangeable images, logos, diapositives ou dessins, de jour comme de nuit. Créez vos propres projections en imprimant sur un film transparent vos photos ou en écrivant avec un feutre indélébile. Entièrement orientable sur plafond, mur ou façade, grâce à un miroir incrusté dans une demi-sphère en aluminium massif. La taille de la projection varie en fonction de la distance entre la lampe et la surface de projection."

"Miss Scope" is the result of a marriage between an industrial projector and light. This table lamp projects the design of your choice against a wall or other surface. Whether pictures, logos, transparencies slides or drawings, you can create your own images with transparency film, photographs or writing on the light with a permanent ink marker.

You can project onto the ceiling or a wall thanks to a mirror located on a half sphere. The size of the projection depends on the distance between the lamp and the target surface."

## Lampe de projection ■ Miss Scope

■ Lampe de projection  
Miss Scope  
Ref : Ms

Ø 14 x H. 51 cm - Alimentation/Cord 2 m/6.6' - Ampoule dichroïque/  
Dicroïc bulb - 1 x Max 50 W - 230 V : E14 - 120 V : E12 - Fournie/Incl -  
+ 3 diapositives + 3 vierges à créer /3 printed slides + 3 virgin to be  
created.



Finitions/  
Finishes

Blanc irisé/White iridescent  
Blanc plissé/White pleated  
Mailles inox polies/Polished stainless steel

Matériaux  
Materials

Acier inoxydable brossé, verre, aluminium massif/Stainless steel, glass,  
plain aluminium.

MADE IN  
FRANCE

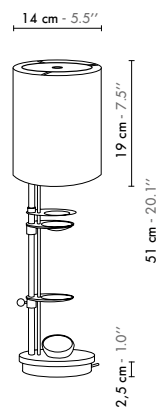

■ Ref : Ms





designheure







# Coloris standards

Standard colors

## MOZAIK\_

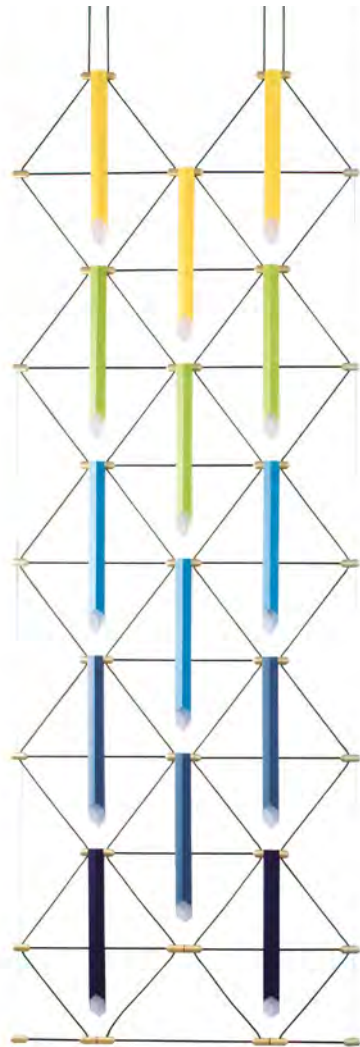

Ref. couleur/Color : 5c  
5 couleurs  
Fil vert kaki DHTT07-450  
5 colors  
Green khaki cord

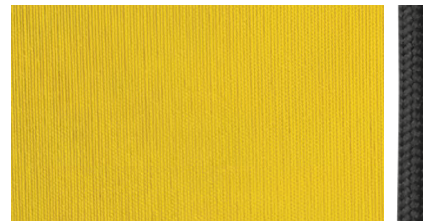

Ref. couleur/Color : j  
Jaune OTTO13  
Fil noir DHTT07-09  
Yellow - Black cord



Ref. couleur/Color : vc  
Vert clair CH548  
Fil vert kaki DHTT07-450  
Light green  
Green khaki cord

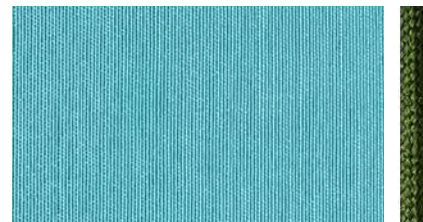

Ref. couleur/Color : bc  
Bleu canard CH415  
Fil vert kaki DHTT07-450  
Duck blue  
Green khaki cord



Ref. couleur/Color : gb  
Gris bleu CT227  
Fil vert kaki DHTT07-450  
Blue grey  
Green khaki cord

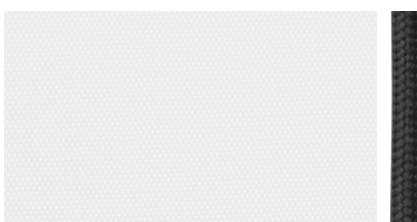

Ref. couleur/Color : b  
Blanc textile TACH928  
Fil noir DHTT07-09  
White fabric - Black cord

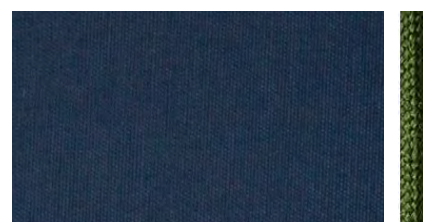

Ref. couleur/Color : bm  
Bleu marine CH158  
Fil vert kaki DHTT07-450  
Navy blue  
Green khaki cord



# FLEUR DE KAOLIN\_



Porcelaine blanche - Laiton  
Fil gris sombre DHTT07-06  
White porcelain - Brass  
Dark grey cord



# PISTYLE\_



Ref. couleur/Color : v  
Vert 29/Vert 29  
Fil vert DHTT07-43  
Green/Green - Green cord

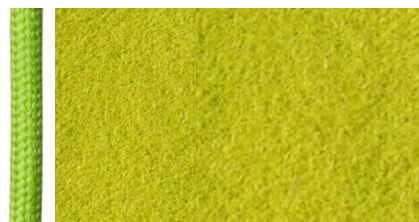

Ref. couleur/Color : bj  
Bleu 36/Jaune 17  
Fil bleu DHTT07-352  
Blue/Yellow - Blue cord



Ref. couleur/Color : vv  
Violet 75/Vert 29  
Fil violet DHTT07-38  
Purple/Green - Purple cord



Coloris pièces acier : Blanc ou Gris anthracite  
Metal parts colors : White or Anthracite grey

# EAU DE LUMIERE\_

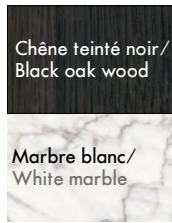

Chêne teinté noir/  
Black oak wood

Marbre blanc/  
White marble



Taille/Size L  
Ref. couleur/Color : go  
Gris KASA54/  
Int. orange TEVA64  
Fil noir DHTT07-09  
Grey/Ins. orange  
Black cord

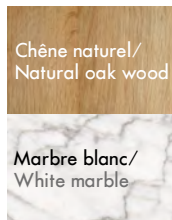

Chêne naturel/  
Natural oak wood

Marbre blanc/  
White marble

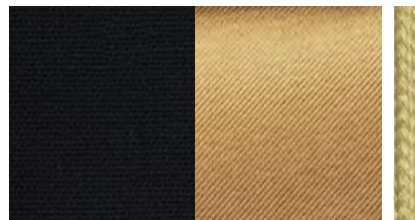

Taille/Size M  
Ref. couleur/Color : no  
Noir TEVA200/  
Int. or RASO 002  
Fil or DHTT07-15  
Black/Ins. gold - Gold cord



Chêne teinté gris/  
Grey oak wood

Marbre blanc/  
White marble

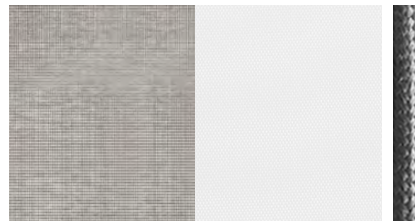

Taille/Size S  
Ref. couleur/Color : gb  
Gris clair PASA006/  
Int. blanc TACH928  
Fil argent DHTT07-05S  
Light grey/Ins. white  
Silver cord



Finitions : marbre ou bois / Finishes : marble or wood

Coloris pièces acier : Blanc ou noir  
Metal parts colors : White or black

# COUTURE\_

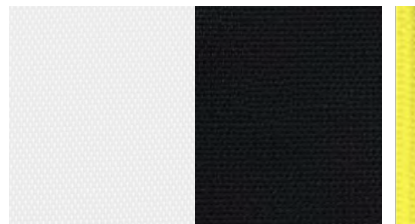

Ref. couleur/Color : bn  
Blanc textile diffusant CH91/  
Int. blanc PVC  
Trapèze noir TEVA200  
Fil jaune DHTT07-102  
White diffusing fabric/  
Ins. white PVC  
Black trapezoid  
Light yellow cord

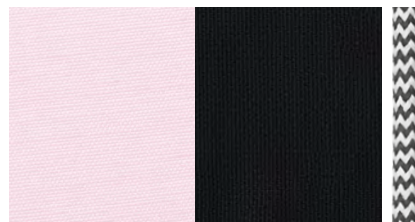

Ref. couleur/Color : rn  
Rose textile diffusant CH17/  
Int. blanc PVC - Trapèze noir  
TEVA200 - Fil chevrons  
noir et blanc DHTT07-90  
Pink diffusing fabric/  
Ins. white PVC  
Black trapezoid  
Black & white zig zag cord

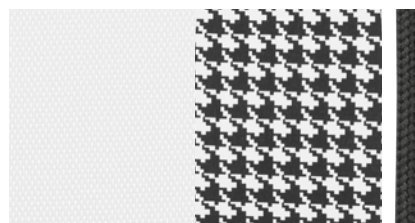

Ref. couleur/Color : bpdp  
Blanc textile diffusant CH91/  
Int. blanc PVC  
Trapèze Pied-de-poule PDP  
Fil noir DHTT07-09  
White diffusing fabric/  
Ins. white PVC - Houndstooth  
trapezoid - Black cord

Coloris pièces acier : Noir  
Metal parts colors : Black

# NENUPHAR\_



Ref. couleur/Color : mt  
Marron KASA56/  
Int. turquoise AQUI77  
Fil marron DHTT07-20  
Brown/Ins. turquoise  
Brown cord

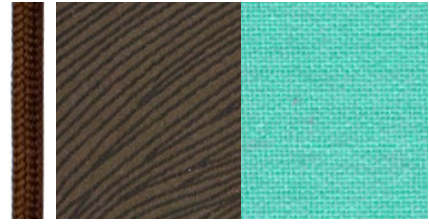
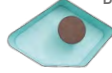

Ref. couleur/Color : go  
Gris KASA54/  
Int. orange TEVA64  
Fil gris DHTT07-06  
Grey/Ins. orange - Grey cord

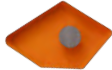

Ref. couleur/Color : nb  
Noir TEVA200/Int. Blanc TACH  
928 - Fil noir DHTT07-09  
Black/Ins. white - Black cord

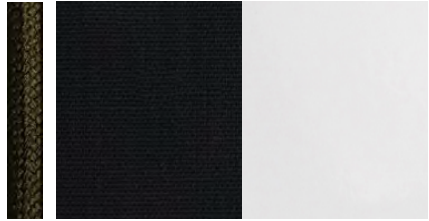

Ref. couleur/Color : no  
Noir TEVA200/Int. PVC OR  
BRILLANT - Fil noir DHTT07-09  
Black/Ins. gold - Black cord

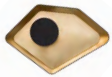

Coloris pièces acier : Blanc  
Metal parts colors : White

# CARGO\_



Ref. couleur/Color : cb  
Blanc textile diffusant CH9 1  
bord. noire/Int. blanc PVC  
Cylindre blanc  
Fil noir DHTT07-09  
White diffusing fabric  
black border/Ins. white PVC  
White cylinder - Black cord

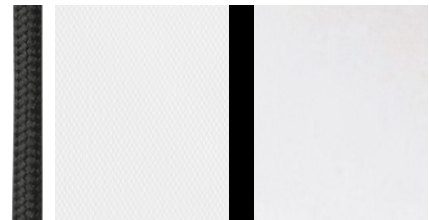

Ref. couleur/Color : cn  
Blanc textile diffusant CH9 1  
bord. noire/Int. blanc PVC  
Cylindre noir laqué LAKF20  
Fil noir DHTT07-09  
White diffusing fabric  
black border/Ins. white PVC  
Black lacquered cylinder  
Black cord

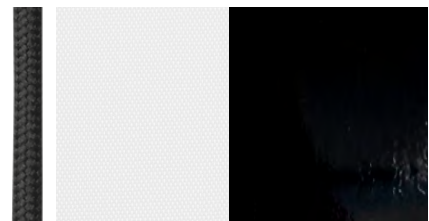

Coloris pièces acier

Metal parts colors

- Modèles à poser ou muraux :  
Cerclage, pied et patère murale : Noir  
- Modèles suspendus : Cerclage noir, patère blanche

- Table, floor or wall models :  
Hoop, base & wall plate : Black  
- Pendant models : Black hoop, white ceiling plate



# LUXIOLE\_

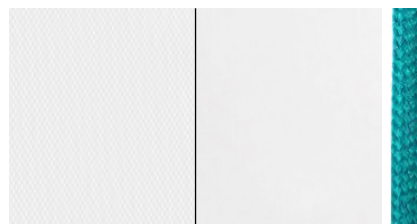

Ref. couleur/Color : b  
TEVA01/Int. PVC BLANC  
Fil Turquoise DHTT07-36  
White/Ins. white  
Turquoise cord

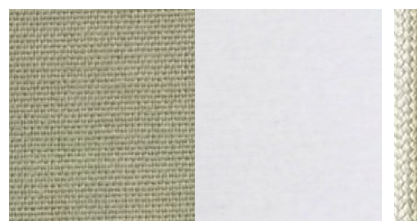

Ref. couleur/Color : kb  
Kaki TEVA572/  
Int. blanc CH91  
Fil kaki DHTT07-2110  
Khaki/Ins. white  
Khaki cord



Ref. couleur/Color : mo  
Marron TEVA589/  
Int. orange TEVA64  
Fil marron DHTT07-20  
Brown/Ins. orange  
Brown cord

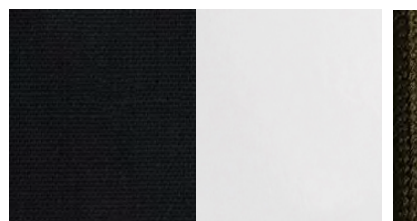

Ref. couleur/Color : nb  
Noir TEVA200/Int. blanc  
laqué\* LUMI01  
Fil noir DHTT07-09  
Black/Ins. white lacquered  
Black cord



Coloris pièces acier : Gris texturé  
Metal parts colors : Textured grey

\*Taille XXL/XXL size :  
Noir TEVA200/Int. blanc CH91  
Black/Int. white

# L'EMPIRIQUE\_

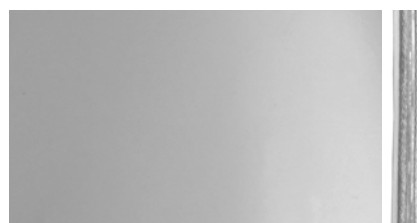

Ref. couleur/Color : a  
PVC gris argent effet miroir  
MIRRARB - Base et cordon  
en PVC transparent  
Silver PVC with mirror effect  
Transparent PVC base and cord

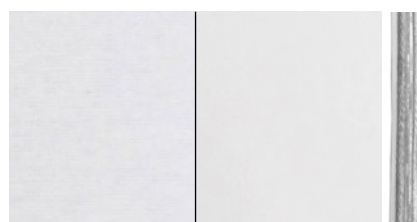

Ref. couleur/Color : b  
Blanc textile diffusant CH91/  
Int. blanc PVC - Base et cor-  
don en PVC transparent  
White diffusing fabric/  
Ins. white - Transparent PVC  
base and cord



# NUAGE\_

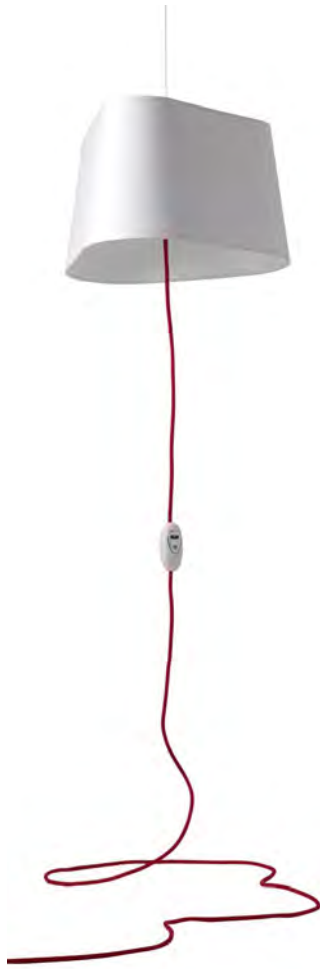

Ref. couleur/Color : b  
Blanc textile diffusant CH9 1/  
Int. blanc PVC  
Fil rouge DHTT07-33  
White diffusing fabric/  
Ins. white - Red cord

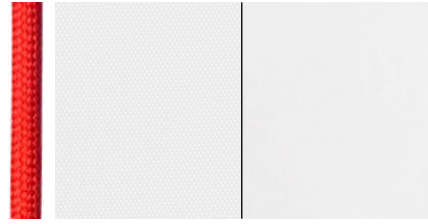

Ref. couleur/Color : bbn  
Blanc textile diffusant CH9 1  
bord. noire/Int. blanc PVC  
Fil noir DHTT07-09  
White diffusing fabric  
black border/Ins. white  
Black cord



Ref. couleur/Color : nj  
Noir laqué LAKF20/  
Int. jaune TEVA20  
Fil jaune DHTT07-101  
Black lacquered/  
Ins. yellow - Yellow cord



Ref. couleur/Color : jo  
Jaune TEVA20 bord. noire/  
Int. PVC OR BRILLANT  
Fil noir DHTT07-09  
Yellow black border/  
Ins. gold - Black cord

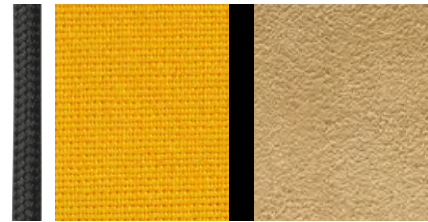

Ref. couleur/Color : go  
Gris TEVA81/  
Int. PVC OR BRILLANT  
Fil or DHTT07-15  
Grey/Ins. gold - Gold cord

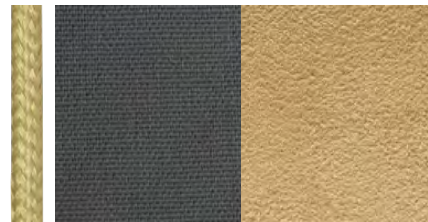

Ref. couleur/Color : ub  
Motif UNIVERSBLANC/  
Int. blanc laqué LUMI 01  
Fil noir DHTT07-09  
White Unvers pattern/  
Ins. white - Black cord

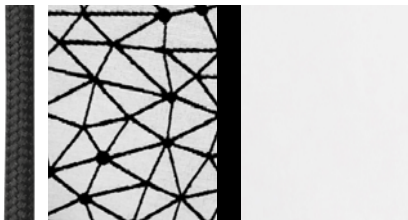
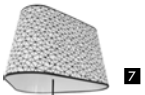

Ref. couleur/Color : un  
Motif UNIVERS NOIR/  
Int. blanc laqué LUMI 01  
Fil noir DHTT07-09  
Black Unvers pattern/  
Ins. white - Black cord

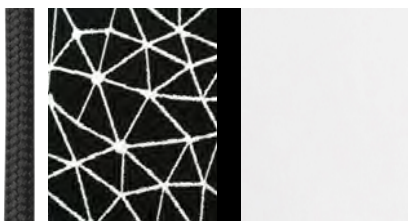

Ref. couleur/Color : bo  
Bleu marine CH158 bord.  
noire/Int. PVC OR BRILLANT  
Fil or DHTT07-15  
Navy blue black border/  
Ins. gold - Gold cord

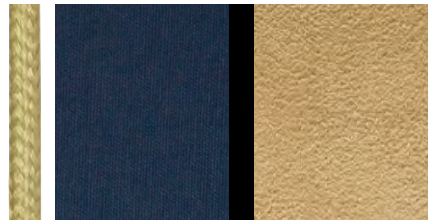

Ref. couleur/Color : r  
Motif RONDO\*/Int. Blanc PVC  
Fil noir DHTT07-09  
Rondo pattern/Ins. white  
Black cord

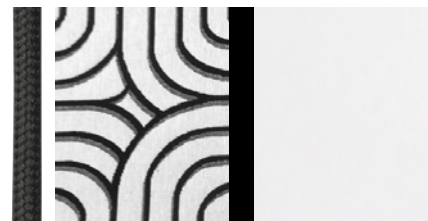

\*Uniquement pour abat-jour XL  
Only for XL lampshade

Coloris pièces acier : 1 2 3 4 5 6 7 8 9 : Blanc 3 4 6 : Noir  
Metal parts colors : White Black

# LIGHTBOOK\_



Ref. couleur/Color : b  
Blanc diffusant CH9 1/  
Int. blanc PVC  
Fil rouge DHTT07-33  
White diffusing fabric/  
Ins. white PVC - Red cord



Ref. couleur/Color : bbn  
Blanc diffusant CH9 1  
bord. noire/Int. blanc PVC  
Fil noir DHTT07-09  
White diffusing black border/  
Ins. white PVC - Black cord

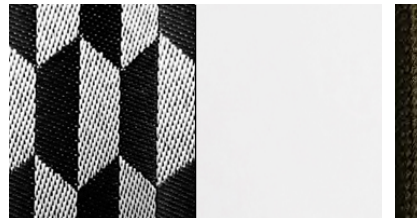

Ref. couleur/Color : dn  
Motif damier noir/  
Int. blanc PVC  
Fil noir DHTT07-09  
Black damier pattern/  
Ins. white PVC - Black cord

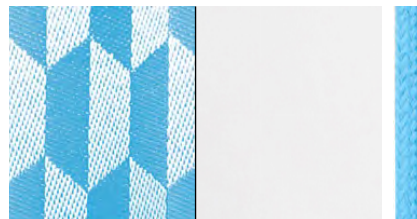

Ref. couleur/Color : db  
Motif damier bleu/  
Int. blanc PVC  
Fil bleu DHTT07-39  
Blue damier pattern/  
Ins. white PVC - Blue cord

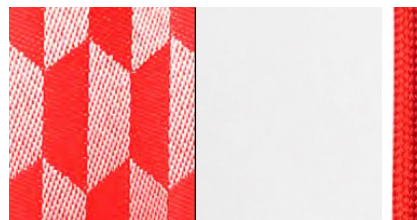

Ref. couleur/Color : dr  
Motif damier rouge/  
Int. blanc PVC  
Fil rouge DHTT07-33  
Red damier Pattern/  
Ins. white PVC - Red cord

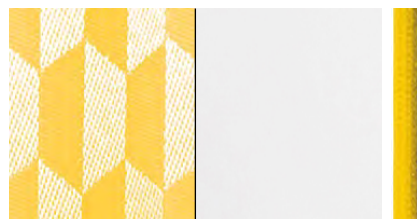

Ref. couleur/Color : dj  
Motif damier jaune/  
Int. blanc PVC  
Fil jaune DHTT07-101  
Yellow damier pattern/  
Ins. white PVC - Yellow cord

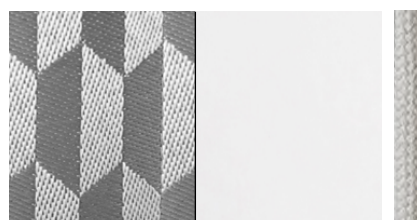

Ref. couleur/Color : dg  
Motif damier gris/  
Int. blanc PVC  
Fil gris DHTT07-05S  
Grey damier pattern/  
Ins. white PVC - Grey cord



Coloris pièces acier : Blanc  
Metal parts colors : White







[www.designheure.com/sur-mesure](http://www.designheure.com/sur-mesure)

## Page Trade-Contract

Retrouvez sur notre site internet l'intégralité des finitions sur mesure.

## Trade-Contract page

Find out on our website all our custom made finishes.

Vous êtes un professionnel en charge d'un projet ? Afin d'en faire une réalisation unique, parfaitement intégrée à l'ensemble du design, et en fonction des quantités, nous pouvons vous proposer de réaliser sur mesure :

- les coloris de fils et d'abat-jour,
- le nombre d'abat-jour et leur taille,
- les longueurs de fils textiles et de câbles acier.

Echantillons :

**Fils** : Notre signature est basée sur le fil textile, élément décoratif de nos luminaires. Nous vous proposons de nombreux coloris autres que les standards. Retrouvez sur notre page "Projets" sur [www.designheure.com](http://www.designheure.com) les dernières nouveautés de fils. Nous pouvons aussi vous faire parvenir la boîte de fils complète.

**Abat-jour** : nous disposons d'une grande palette de couleurs et de textures d'abat-jour. Dans le cadre d'un projet, nous pouvons vous faire parvenir les coloris standards ou des échantillons correspondant aux coloris recherchés.

Consultez nous.

You are a professional in charge of a project ? To make it a unique, perfectly integrated into the overall design, according to the quantities, we can offer to make custom of:

- the colors of cords and lampshades,
- the number of lampshades, and size,
- lengths of textiles cords and steel cables.

Samples:

**Cords**: Our signature is based on textile electric cords, to fit with our decorative lightings. We offer many colors other than standard. Find on our "Projects" page on [www.designheure.com](http://www.designheure.com), the latest colors. We can also send you the full boot of cords.

**Lampshade**: we have a wide range of colors and textures of lampshades. As part of a project, we can send you samples of standard colors or special ones, corresponding to the desired color.

Please consult us.

DHHT07-99  
DHHT07-95  
DHHT07-33  
DHHT07-11  
DHHT07-310  
DHHT07-291  
DHHT07-28  
DHHT07-38  
DHHT07-351  
DHHT07-399  
DHHT07-352  
DHHT07-39  
DHHT07-36  
DHHT07-402  
DHHT07-45  
DHHT07-43  
DHHT07-450  
DHHT07-42  
DHHT07-20  
DHHT07-1010  
DHHT07-101  
DHHT07-102  
DHHT07-44  
DHHT07-50  
DHHT07-53  
DHHT07-52  
DHHT07-510  
DHHT07-2110  
DHHT07-212  
DHHT07-051  
DHHT07-01A  
DHHT07-01  
DHHT07-15  
DHHT07-16  
DHHT07-05S  
DHHT07-06  
DHHT07-061  
DHHT07-09  
DHHT07-790  
DHHT07-92  
DHHT07-90  
DHHT07-91









# Références

Principaux projets professionnels réalisés

NEW-YORK  
PARIS  
MONTPELLIER  
NAMUR  
OUR  
TREVES  
LONDRES  
LYON  
ZURICH  
BARCELONE  
MOSCOU  
NANTERRE  
INTERLAKEN  
CHAMONIX

**[www.designheure.com](http://www.designheure.com)**

Page projets / Projects page

Retrouvez sur notre site internet l'intégralité de nos références ainsi que nos photos de projets marquants.

Follow us on our website and discover all our references and pictures of outstanding projects.



VEIGNE, Hôtel Domaine de la Tortinière - Arch. Scènes en Couleurs. Photos Anne-Emmanuelle Thion ©

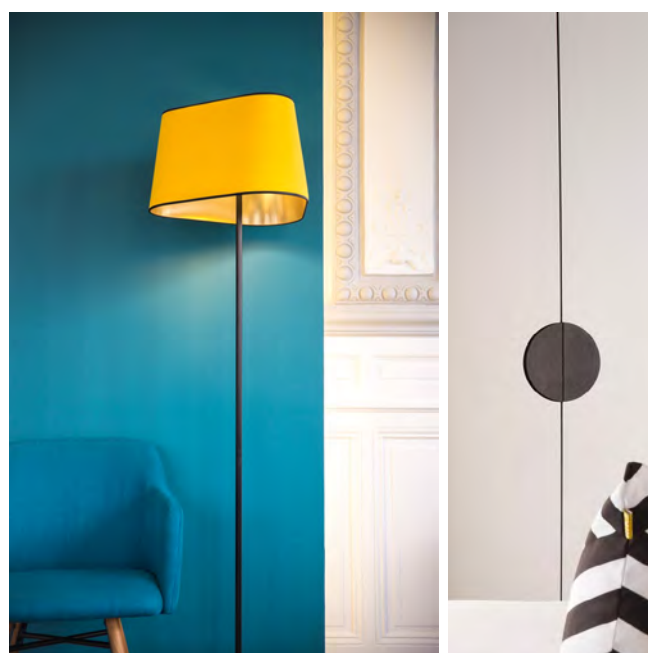
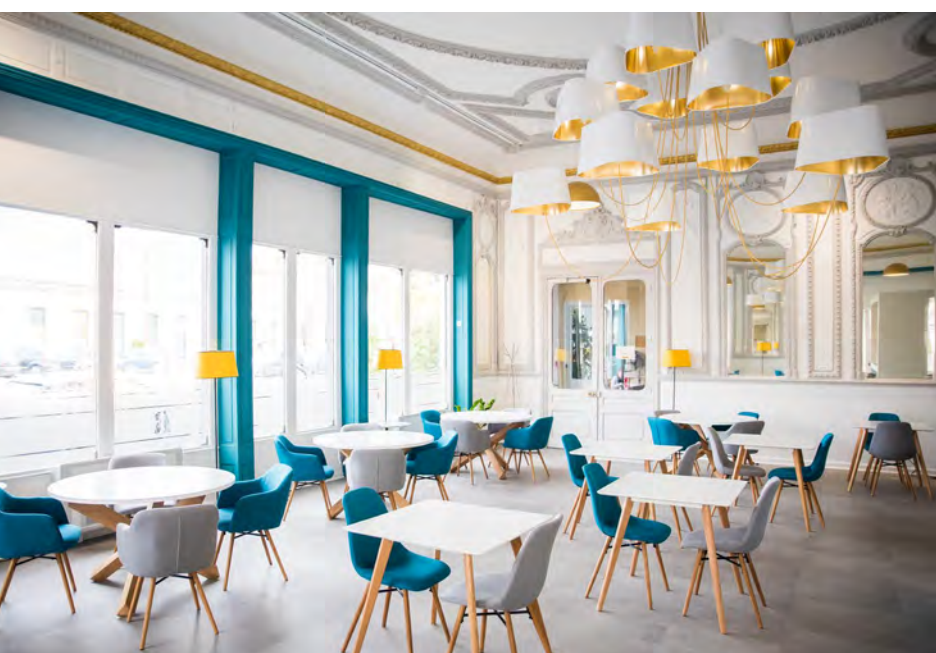

ALES, Restaurant Le Riche - Arch. Christophe Urtis. Photos jonathan-vael.fr ©

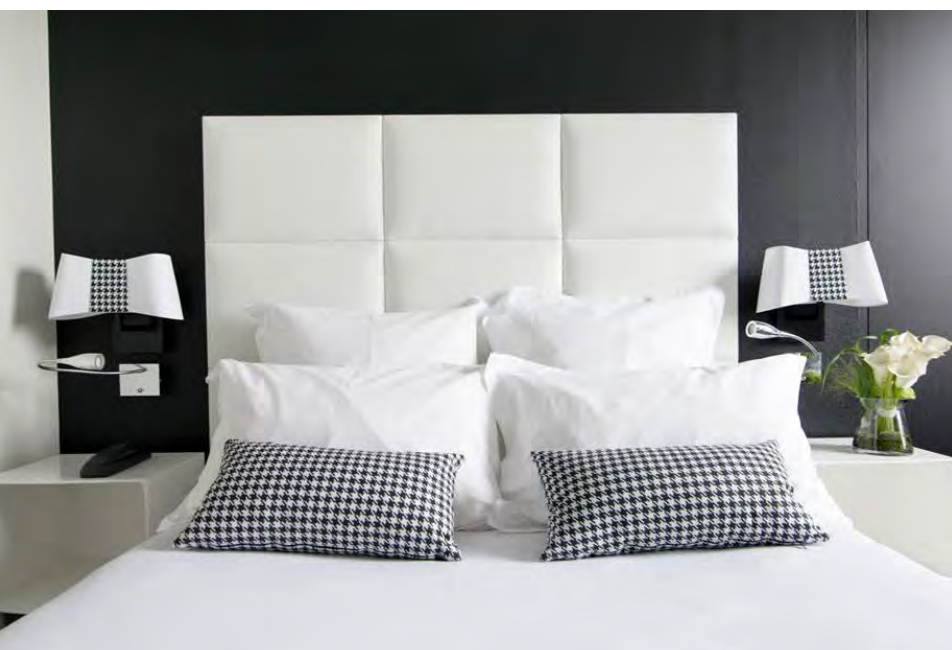

BELFORT, Hôtel Les Capucins - Photos Olivier Tisserand ©





NEW-YORK, The Printing House  
Arch. Workshop/ Apd ©



PARIS, Hôtel Ekta - Arch. Nuel & Novaom - Photos Christophe Bielsa ©

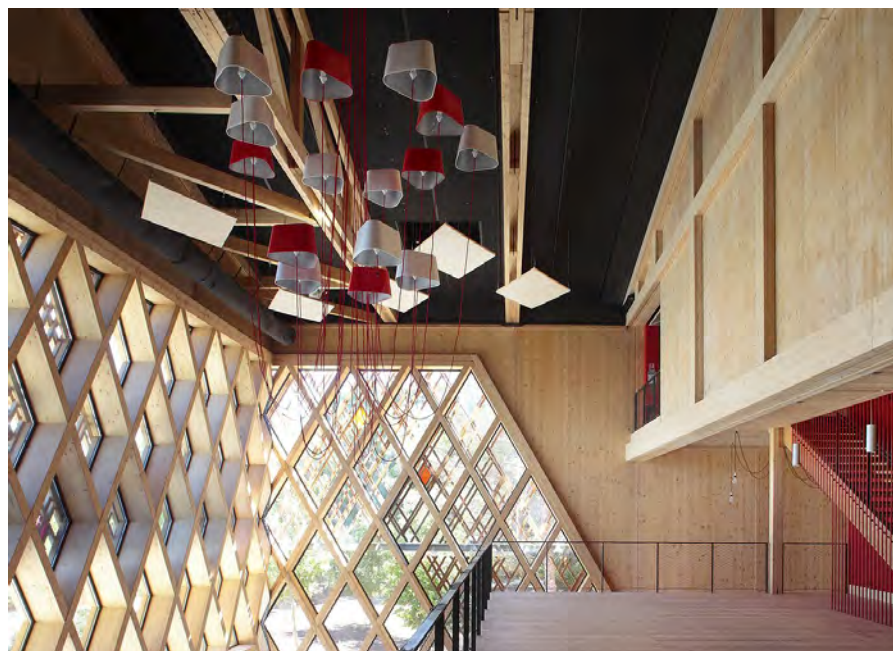

MONTPELLIER, Théâtre Jean-Claude Carrière - A+ Architecture - Photos MC. Lucat ©





MANE, Hôtel Le Couvent des Minimes - Arch. Atelier P. Borde & Entre les murs - Photos Angèle Vuillet ©



OUR, Restaurant - Les terrasses de l'our - Arch. Frédérique Sosson - Photo DB creation ©



TREVES, Hôtel Park Plaza - Arch. Designers House ©





NAMUR, Hôtel The Royal Snail - Arch. Buro5 - Julie Valette - Photos François Mainil ©



ROCHE S/YON, Opticien  
Arch Studio Sd ©



MONTPELLIER, Hôtel Océania - Arch. Igloo ©



PARIS, Hôtel Renaissance, Hippodrome St. Cloud - Arch. Agence Nuel ©



LONDRES, Projet privé - Arch. Magisco ©







LYON, BNP Paribas - Arch. V. Racanière ©

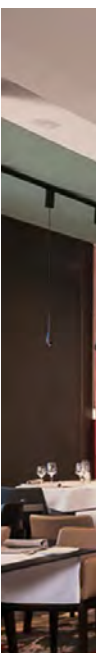
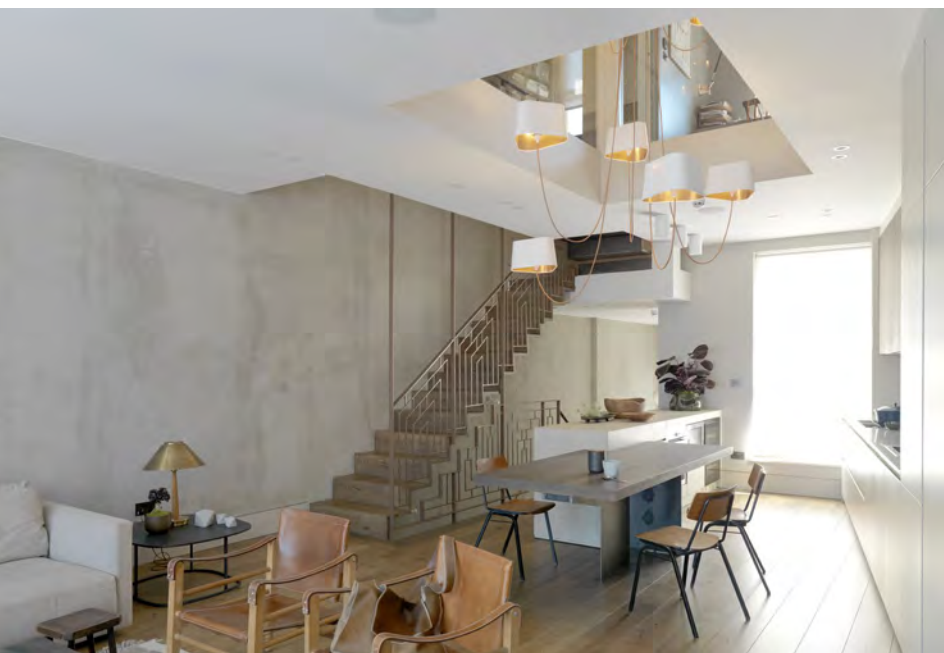

LONDRES, Projet privé - Arch. Tala Mikdashi ©



BARCELONE, Hôtel W - Arch. Studio Gaia ©



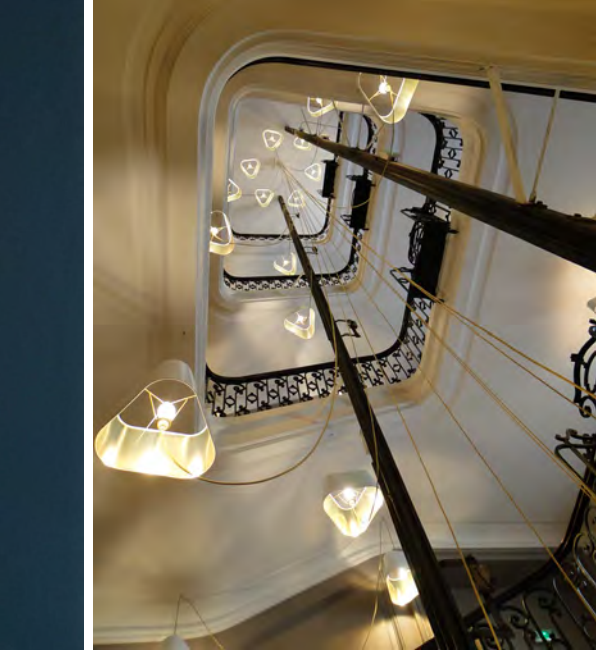

MONTPELLIER, Hôtel Océania Le Métropole - Arch. Igloo Architectures ©

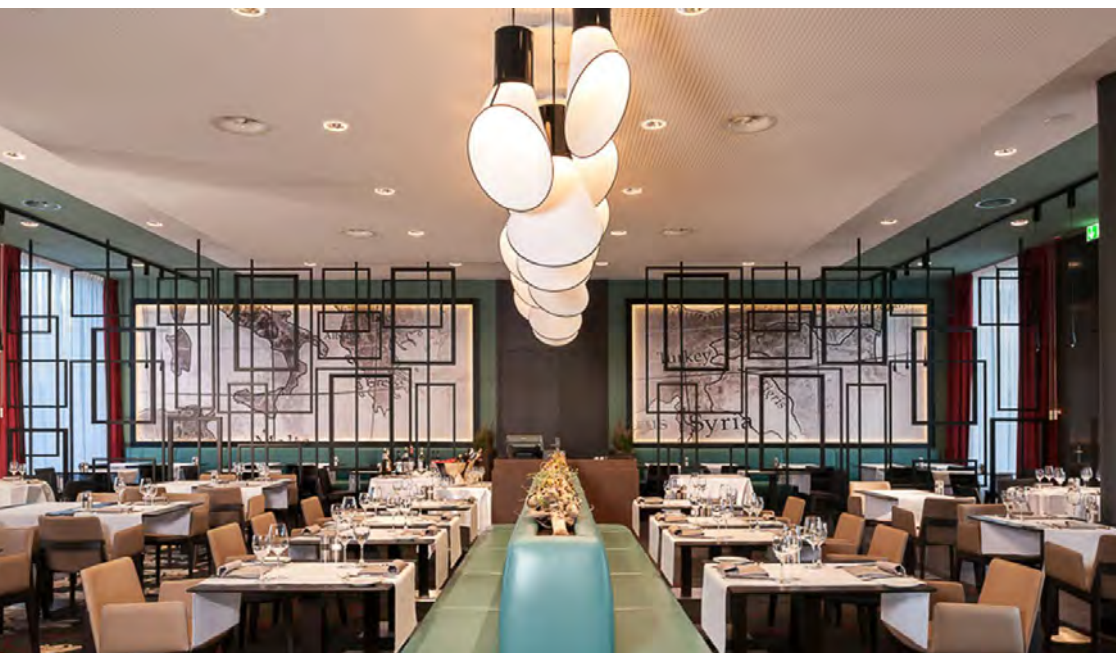

ZURICH, RESTAURANT Basilico Hôtel Dorint Airport-Hotel - Arch. Kitzig ©



WICKRANGE, Salle de réception - An Haffen ©



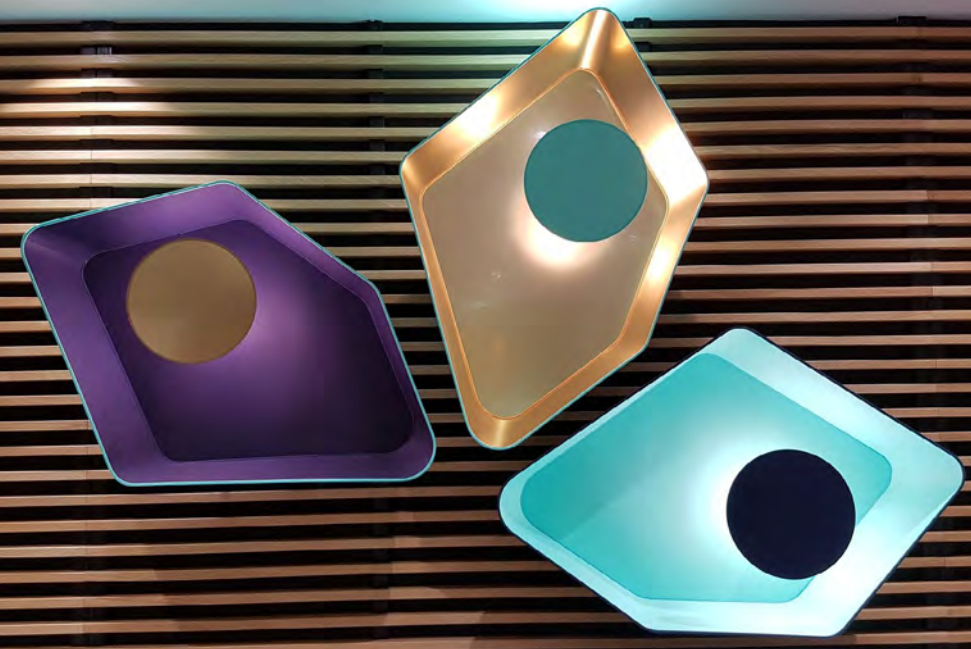

MONTPELLIER, Clinique - Arch. A+ Architecture ©



NANTERRE, Bureaux Tishman Speyer - Tour Pacific - Arch. Sahuc & Katchoura. Photos Marie-Sophie Leturcq ©



CHAMONIX, Restaurant-Hôtel Le Mont-Blanc - Arch. SM Design ©





INTERLAKEN, Hôtel Royal St. Georges - Arch. Hiram ©

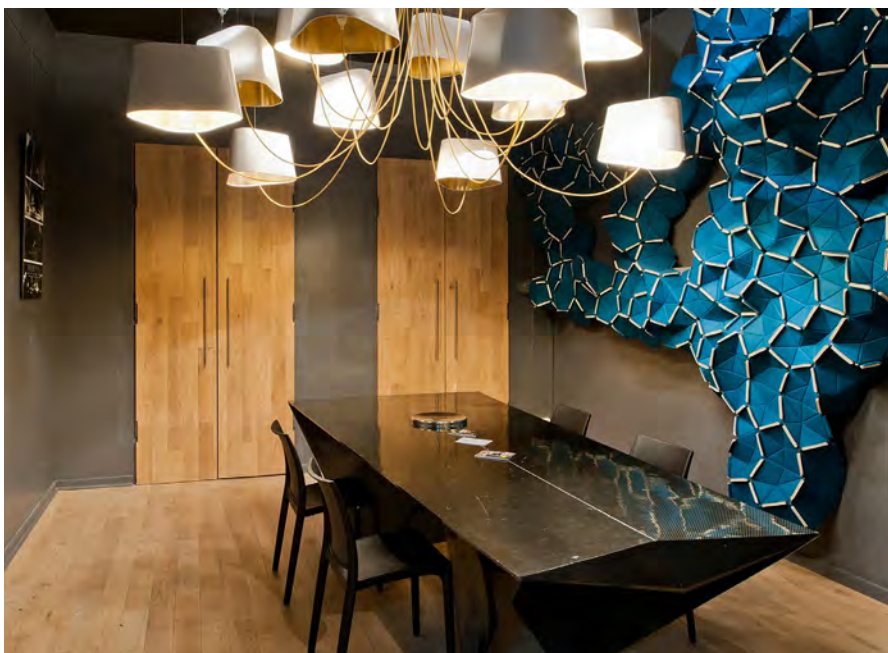

PARIS, Agence de publicité Eric Berthès ©



PARIS, Projet privé  
Arch. Agence Faure. Photo Philippe Charlot ©



ST CYPRIEN, Hôtel - Restaurant l'Almandin - Arch. Kristian Gavaille ©



Lampes / Lampadaires

Appliques

## Mozaik

Daide Oppizzi

## Fleur de Kaolin

Designheure Studio & **HAVILAND**  
LIMOGES FRANCE 1845

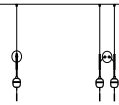

## Pistyle

Daide Oppizzi

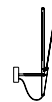

## Eau de lumière

Daide Oppizzi



## Couture

Emmanuelle Legavre

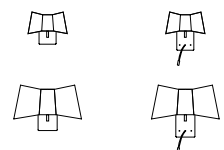
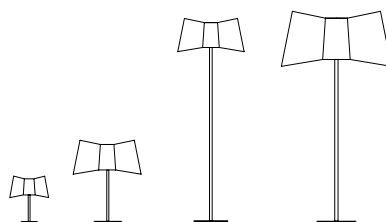

# PANORAMA

Overall view

## Suspensions / Plafonniers

## Lustres

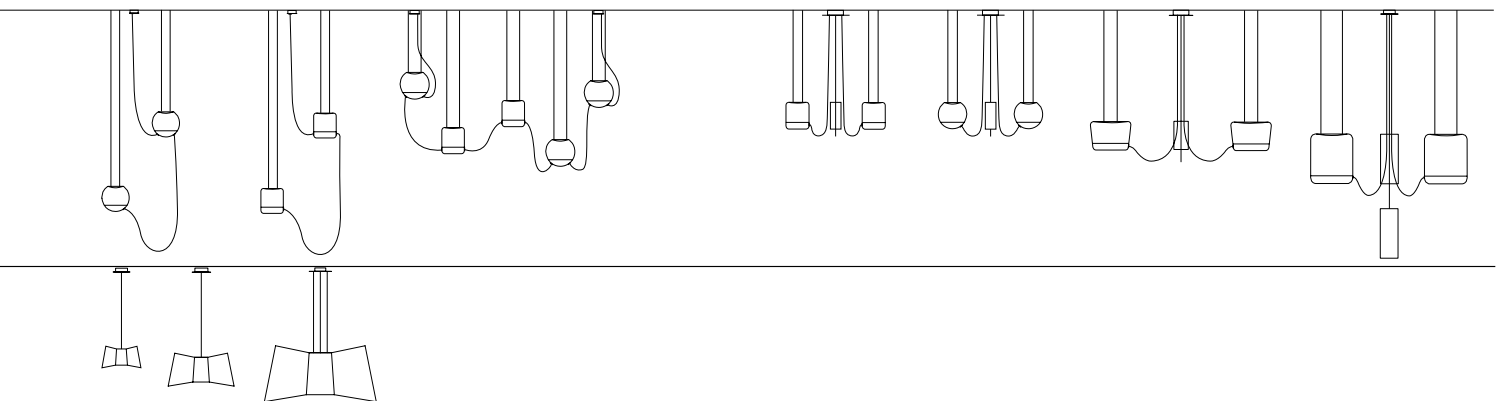
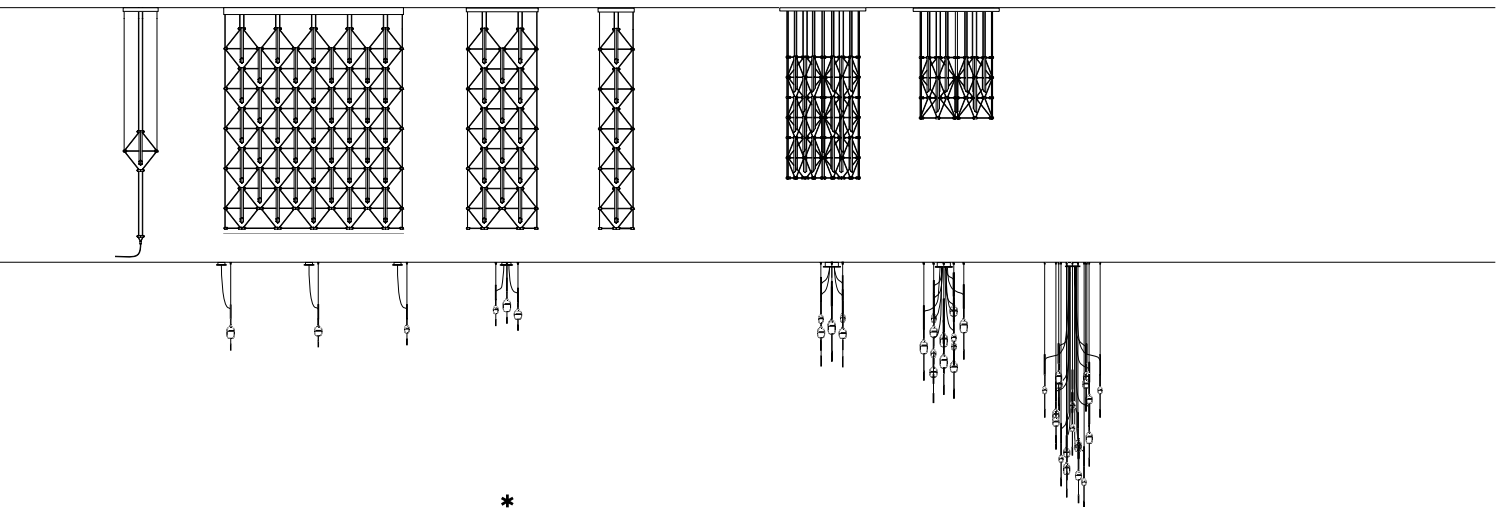

\* Disponible en plusieurs tailles  
Available in several sizes

Lampes / Lampadaires

Appliques

**Nénuphar**

Kristian Gavoille

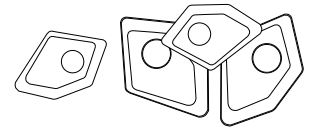

\* \*

**Cargo**

Hervé Langlais

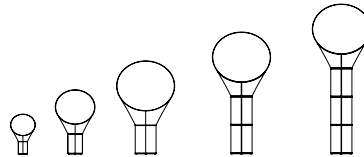

**LuXiole**

Kristian Gavoille

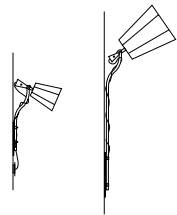
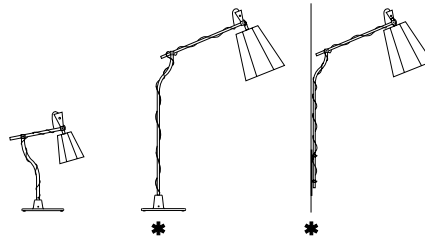

\* \*

**Nuage**

Hervé Langlais

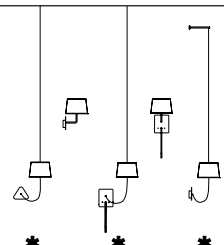
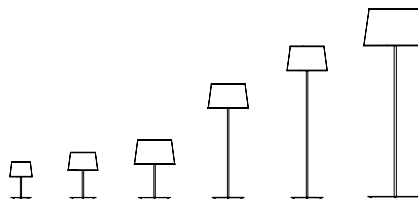

\* \* \*

**Rééditions/Autres**

Raoul Raba

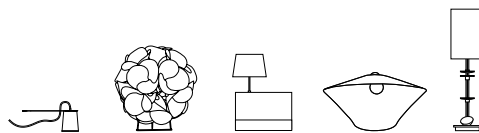



# PANORAMA

Overall view

## Suspensions / Plafonniers

## Lustres

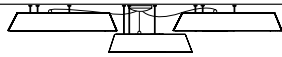
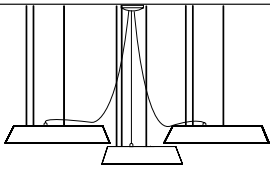

\*

\*

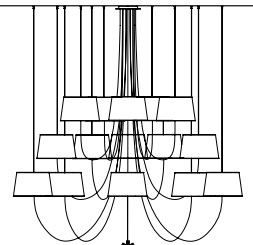
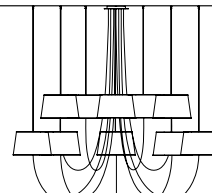
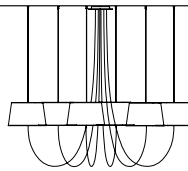
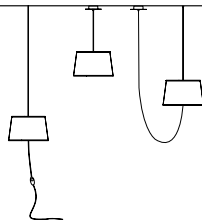
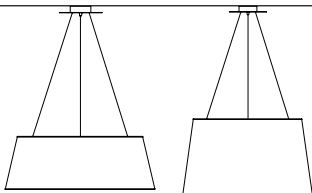
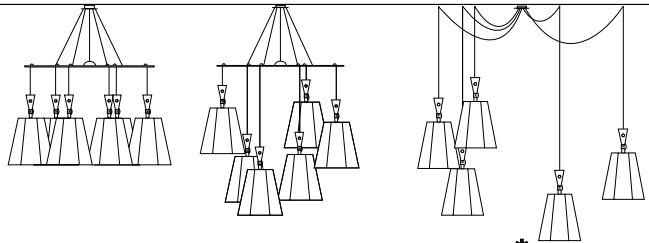
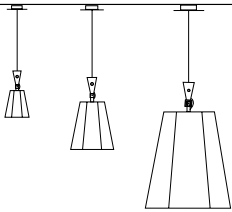
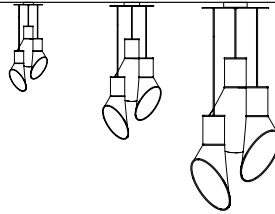
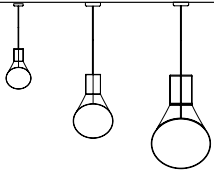

\*

\*

\*







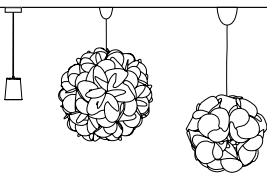





















\*

\*

\*



\* Disponible en plusieurs tailles  
Available in several sizes

	Classe d'isolation I/Insulation class I Isolement basique avec connexion fil de terre/Basic insulation with earth wire.
	Classe d'isolation II/Insulation class II Double isolement ou renforcé sans connexion fil de terre/Reinforced or double insulation, without earth wire.
	Classe d'isolation III / Insulation Class III Luminaire prévu pour une tension nominale inférieur à 50V/Lighting suitable for a voltage less than 50.
	Produit conforme aux directives de la communauté européenne/Product conforms to european community directives.
	Produit conforme aux normes UL et CSA applicables aux Etats-Unis et au Canada/Compliant product to the UL and CSA standards for US and Canada.
	Produit conforme aux normes Eurasiennes (Russie, Biélorussie and Kazakhstan)/EurAsian Conformity ( Russia, Belarus and Kazakhstan).
	Indice de rendu de couleur/Color rendering index.
	Diode Electroluminescente : semi-conducteur électronique qui ne nécessite qu'un très faible apport énergétique pour émettre de la lumière/ Light Emitting Diode: Electronic semiconductor which requires only a very low energy to emit light.
	Source lumineuse LED intégrée/integrated LED sources.
	Ø max 60 mm/ bulb Ø max 2.4"
	H. max 90 mm/ bulb MOL 3.5"
	Ampoule LED dépolie/ LED Frosted bulb
	Ampoule globe LED/LED globe bulb.
	Ampoule à calotte argentée/Silver cap bulb.
	Ampoule dichroïque halogène/Halogen dichroic bulb.
	Ampoule LED GU4 12 V/ GU4 12 V LED bulb.
	Ampoule LED G9/ G9 LED bulb.
	Abj/Ls Abat-jour/Lampshade.
	Ø 100 cm Diamètre conseillé de pose/Recommended diameter for installation.
	Produit ajustable selon le(s) sens indiqué(s)/Adjustable product according to the direction(s) indicated.
	Hauteur maximale (taille maximale de l'ampoule par rapport à la taille de l'abat-jour)/Maximum Overall Length (bulb maximum size fitting with lampshade size).
	L Longueur/Length.
	I Largeur/Width.
	H Hauteur/Height.
	' Pied/Feet. 1' = 30,5 cm.
	" Pouce/Inch. 1" = 2,54 cm.
	cm Centimètre/Centimeter. 1 cm. = 0.4"
	m Mètre/Meter. 1 m. = 3.28'

# Consommation énergétique

Energy consumption

## Étiquettes énergétiques par collection Energy labels by collection

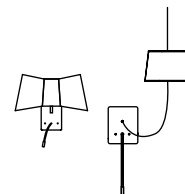
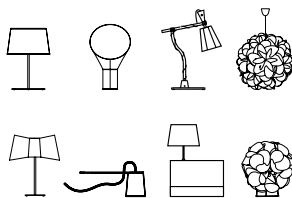
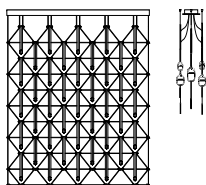

**Designheure**

Ce luminaire est compatible avec des ampoules LED des classes énergétiques :

A++	LED	
A+		
A	}	
B		
C		
D		
E		

Le luminaire est vendu avec une ampoule de la classe énergétique : **A+**

874/2012

**Designheure**

Ce luminaire est compatible avec des ampoules des classes énergétiques :

A++	}	
A+		
A	}	
B		
C		
D		
E		

874/2012

**Designheure**

Ce luminaire comporte des lampes à LED intégrées et des douilles pour ampoules des classes énergétiques :

A++	LED	
A+		
A	}	
B		
C		
D		
E		

Les lampes à LED de ce luminaire ne peuvent pas être changées.

874/2012



**Designheure**

Ce luminaire comporte des lampes à LED intégrées.

A++	LED	
A+		
A	}	
B		
C		
D		
E		

Les lampes à LED de ce luminaire ne peuvent pas être changées.

874/2012

**Designheure**

Ce luminaire est compatible avec des ampoules des classes énergétiques :

A++	}	
A+		
A	}	
B		
C		
D		
E		

Le luminaire est vendu avec une ampoule de la classe énergétique : **A**

874/2012

**Designheure**

Ce luminaire est compatible avec des ampoules des classes énergétiques :

<del>A++</del>	}	
<del>A+</del>		
A	}	
B		
C		
D		
E		

Le luminaire est vendu avec une ampoule de la classe énergétique : **B**

874/2012



**Siège social / Headquarters  
Show-room France**

Designheure SAS  
5, Place Delille  
34200 Sète - France

✉ **France & Export office**  
contact@designheure.com  
Tel : 33 (0)4 67 53 99 63

✉ **North America office**  
contactusa@designheure.com

@ **www.designheure.com**

**Photographies**

Olivier Maynard  
Michel Bousquet  
Franck Beloncle  
Pyxeos

**Propriété intellectuelle/Intellectual property**

La marque Designheure® et les dessins et modèles© des créations sont déposées - Propriété de la SAS Designheure.  
The registered Designheure Trademark® and the models© of the creations are the property of Designheure SAS.

**Modifications/Improvements**

Photos non contractuelles/Non contractual pictures.

Designheure se réserve le droit de faire des modifications et/ou améliorations de nature technique ou esthétique sur ses modèles et produits à tout moment et sans préavis. Pour tout complément d'information, vous pouvez vous rendre sur le site [www.designheure.com](http://www.designheure.com)

Designheure SAS reserves the right to make modifications and improvements of a technical or aesthetic nature to the products at any time without prior notice. For further information, please visit [www.designheure.com](http://www.designheure.com)



**Siège social  
Headquarters  
Show-room France**  
Designheure SAS  
5, Place Delille  
34200 Sète - France

**France & Export office**  
contact@designheure.com  
Tel : 33 (0)4 67 53 99 63

**North America office**  
contactusa@designheure.com

**[www.designheure.com](http://www.designheure.com)**

